



# CLASSIC INSTRUMENTS

PERFORMANCE • GAUGES

# Table of Contents

Performance Series Explained.....	2-3
Performance Bezel.....	4
Upgrade Options.....	5
<b>Instruments</b>	
Fuel Gauges.....	6
Air Pressure Gauges.....	7
Water Temperature Gauges.....	8
Transmission Temperature Gauges.....	9
Oil Temperature Gauges.....	10
Stock Eliminator Temperature Gauges.....	11
Volt Gauges.....	12
Boost/Vac Gauges.....	13
Boost Gauges, 30PSI & 60PSI.....	14
Fuel Pressure Gauges, 15PSI & 100PSI.....	15
Brake Pressure Gauges.....	16
Oil Pressure Gauges.....	17
Tachometers.....	18
Air/Fuel Ratio Gauges.....	19
Cylinder Head Temperature Gauges.....	20
Exhaust Gas Temperature Gauges.....	21
Outside Air Temperature Gauges.....	22
Matching Speedometers & Tachometers.....	23
Three Gauge Sets.....	24-25
Five & Six Gauge Sets.....	26-27
Sending Units.....	28
Mounting Accessories.....	29
Dimensions.....	30
Part Number Index.....	31-40

Visit us online or call for details and order placement.  
[classicinstruments.com](http://classicinstruments.com) | 800.575.0461



**PERFORMANCE  
GAUGES**

**CLASSIC INSTRUMENTS**

Classic Instruments is the only after-market instrument manufacturer to offer a complete lineup of instruments to cover every monitoring need. With a full-sweep, each gauge provides greater accuracy and readability while the rugged air-core movement coupled with microprocessor technology offers long-lasting precision and durability. Also see our traditional, short-sweep instruments.



## DESIGNED & TESTED BY RACERS

### All full-sweep gauges feature...

- A rugged air core movement for durability
- Microprocessor technology for precision
- Push-button calibration
- An integrated red warning light
- An additional warning indicator light output
- Data logging compatibility
- LED lighting, choose between warm or cool white during installation
- Included installation hardware, wiring harness, and necessary sending unit
- A programmable resistance range on fuel gauges for compatibility with any fuel sending unit

Also see our traditional short-sweep gauges available in select instruments across all seven performance series. Get all the performance style you want in a simple, straightforward instrument.

For complete part numbers on all gauges and accessories please see part number index beginning on page 31.



# SEVEN GRAPHIC STYLES

## AutoCross Gray™

The AutoCross Gray Series features a modern sport appearance with standard matte black low-step bezels, flat glass, and white pool-cue pointers. The dial faces feature clear, concise numerals and indices that are easy to read at any speed.

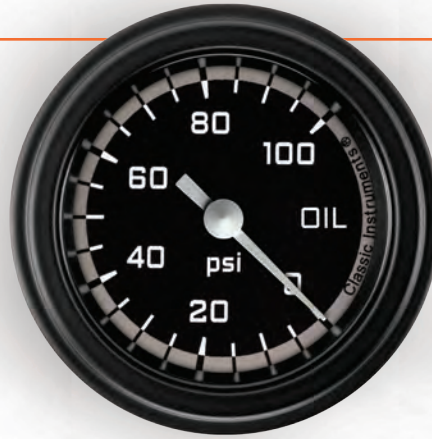

AutoCross Gray

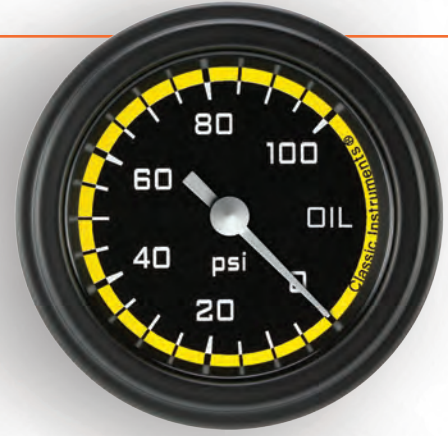

AutoCross Yellow

## AutoCross Yellow™

Take all the style and functionality of the AutoCross Gray series and add a touch of racing yellow and you get the AutoCross Yellow Series.

## G-Stock™

Ensure a bold look with the G-Stock Series featuring brilliant orange pool-cue pointers, flat glass, and stainless steel low-step bezels.



G-Stock

## Hot Rod®

One of the first designs offered by Classic Instruments, the Hot Rod Series is the ultimate high contrast, easy to read design. It features bright white numerals, white pool-cue pointers, stainless steel low-step bezels, and flat glass.



Hot Rod



Velocity Black



Velocity White



White Hot



### Velocity Black™

Make a bold statement about speed with the Velocity Black Series. It features bright white numerals with orange accents, iridescent orange pool-cue pointers, matte black low step bezels, and flat glass lenses. Speedometers read up to 160MPH and Tachometers read up to 10,000RPM.

### Velocity White™

Get the bold fast look of the Velocity Black Series in a lighter style with the Velocity White Series.

### White Hot™

This simple, straightforward design features rich black indices and numerals on a bright white face for easy monitoring with a quick glance. The series also features black pool-cue pointers, flat glass, and stainless steel low-step bezels.

All photos show which pointer, bezel, and diffuser options are standard with each series. Changes are available as upgrade options.

### Don't Forget!

We offer custom graphic services too! You can change the color, add your logo, or completely customize the graphics with ease.

**Just give us a call.**

Visit us online or call for details and order placement.  
[classicinstruments.com](http://classicinstruments.com) | 800.575.0461

## Performance Bezel

---

Classic Instruments' Performance Bezel has a taller, contoured profile designed with racing in mind.

Available on all 2 5/8" gauges only.



Matte Black



Brushed Aluminum

Visit us online or call for details and order placement.  
[classicinstruments.com](http://classicinstruments.com) | 800.575.0461

## Bezel Options

The bezel is the outer ring that holds the glass to the gauge cup and seals the gauge. Bezels for our 2 1/8" gauges are available in Black Chrome Radial (A), Matte Black Low Step (B), Stainless Radial (C), Stainless Low Step (D), Stainless High Step (E).

Our 2 5/8" gauges are available with Matte Black Low Step (F), Matte Black Performance (G), Brushed Aluminum Performance (H), Stainless Low Step (I), or Stainless Radial (J) bezels. All Radial bezels only allow for the use of curved glass.



## Glass Options

Standard production gauges use glass lenses that resist fogging and scratching. Curved (A) or flat (B) glass lenses are available. In most cases the glass style can be specified based on your personal preference with the exception of all Radial bezels which only allow for the use of curved glass.

## Diffuser Options

The diffuser is a pressed metal trim ring within the gauge that is visible beneath the glass along the outer edge of the dial face. Most standard gauges offer the option to specify a diffuser color different from that of the gauge face. Standard color options include: Red (A), White (B), Black (C), Nickel (D), Gray (E), Tan (F), or Silver (G).



## Light Intensifier Ring

To improve visibility and allow the gauge face to be as large as possible, our new 2 5/8" gauges do not have a diffuser. Instead each gauge has a light intensifier ring to evenly disperse and intensify the internal lighting provided by the gauge.

## Pointer Options

Pointer style and color can be specified and changed for any standard production gauge. Style and color options are outlined below. Other colors are available by special order. All pointers may be ordered with a spun aluminum hub.

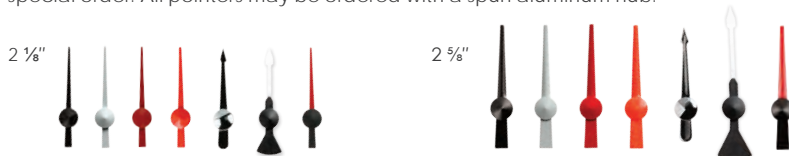





2 5/8"



2 1/8"



2 1/8"



2 5/8"

- 2 1/8" Short-sweep Fuel Gauge
- 2 1/8" Full-sweep Fuel Gauge
- 2 5/8" Short-sweep Fuel Gauge
- 2 5/8" Full-sweep Fuel Gauge
- All seven series

All full-sweep fuel gauges feature a programmable resistance range.

All short-sweep gauges are available in multiple resistance ranges, see page 28.

Visit us online or call for details and order placement.  
[classicinstruments.com](http://classicinstruments.com) | 800.575.0461



- 2 1/8" Full-sweep Air Pressure Gauge
- 2 5/8" Full-sweep Air Pressure Gauge
- All seven series



# Water Temperature Gauges

Available



2 5/8"



2 1/8"



2 1/8"



2 5/8"

- 2 1/8" Short-sweep Water Temperature Gauge
- 2 1/8" Full-sweep Water Temperature Gauge
- 2 5/8" Short-sweep Water Temperature Gauge
- 2 5/8" Full-sweep Water Temperature Gauge
- All seven series

Visit us online or call for details and order placement.  
[classicinstruments.com](http://classicinstruments.com) | 800.575.0461

- 2 1/8" Short-sweep Transmission Temperature Gauge
- 2 1/8" Full-sweep Transmission Temperature Gauge
- 2 5/8" Short-sweep Transmission Temperature Gauge
- 2 5/8" Full-sweep Transmission Temperature Gauge
- All seven series



2 5/8"



2 1/8"



2 5/8"



2 1/8"



## Oil Temperature Gauges

Available



2 5/8"



2 1/8"



2 1/8"



2 5/8"

- 2 1/8" Short-sweep Oil Temperature Gauge
- 2 1/8" Full-sweep Oil Temperature Gauge
- 2 5/8" Short-sweep Oil Temperature Gauge
- 2 5/8" Full-sweep Oil Temperature Gauge
- All seven series

Visit us online or call for details and order placement.  
[classicinstruments.com](http://classicinstruments.com) | 800.575.0461

- 2 1/8" Full-sweep Stock Eliminator Temp. Gauge
- 2 5/8" Full-sweep Stock Eliminator Temp. Gauge
- All seven series

The stock eliminator temperature gauge is designed specifically for stock eliminator drivers who need lower temperature readings.



## Volt Gauges

Available



2 5/8"



2 1/8"



2 1/8"



2 5/8"

- 2 1/8" Short-sweep Volt Gauge
- 2 1/8" Full-sweep Volt Gauge
- 2 5/8" Short-sweep Volt Gauge
- 2 5/8" Full-sweep Volt Gauge
- All seven series

Visit us online or call for details and order placement.  
[classicinstruments.com](http://classicinstruments.com) | 800.575.0461



2 1/8" Full-sweep Boost/Vac Gauge  
2 5/8" Full-sweep Boost/Vac Gauge  
All seven series



## Boost Gauges, 30 PSI & 60 PSI

Available

2 1/8" Full-sweep Boost Gauge, 30PSI

2 1/8" Full-sweep Boost Gauge, 60PSI

2 5/8" Full-sweep Boost Gauge, 30PSI

2 5/8" Full-sweep Boost Gauge, 60PSI

All seven series



2 5/8" 30PSI



2 1/8" 30PSI



2 5/8" 60PSI



2 1/8" 60PSI

Visit us online or call for details and order placement.  
[classicinstruments.com](http://classicinstruments.com) | 800.575.0461

- 2 1/8" Full-sweep Fuel Pressure Gauge, 15PSI
  - 2 1/8" Full-sweep Fuel Pressure Gauge, 100PSI
  - 2 5/8" Full-sweep Fuel Pressure Gauge, 15PSI
  - 2 5/8" Full-sweep Fuel Pressure Gauge, 100PSI
- All seven series



2 5/8" 100PSI



2 1/8" 15PSI



2 5/8" 15PSI



2 1/8" 100PSI





2 1/8" Full-sweep Brake Pressure Gauge  
2 5/8" Full-sweep Brake Pressure Gauge  
All seven series

Visit us online or call for details and order placement.  
[classicinstruments.com](http://classicinstruments.com) | 800.575.0461

- 2 1/8" Short-sweep Oil Pressure Gauge
- 2 1/8" Full-sweep Oil Pressure Gauge
- 2 5/8" Short-sweep Oil Pressure Gauge
- 2 5/8" Full-sweep Oil Pressure Gauge
- All seven series



2 5/8"



2 1/8"



2 5/8"



2 1/8"

# Tachometers

Available



2 1/8" Full-sweep Tachometer  
2 5/8" Full-sweep Tachometer  
All seven series

AutoCross and Velocity series tachometers  
are 10,000 rpm

G-Stock, Hot Rod, and White Hot  
tachometers are 8,000 rpm

Visit us online or call for details and order placement.  
[classicinstruments.com](http://classicinstruments.com) | 800.575.0461



- 2 1/8" Full-sweep Air/Fuel Ratio Gauge
- 2 5/8" Full-sweep Air/Fuel Ratio Gauge
- All seven series



## Cylinder Head Temperature Gauges

Available

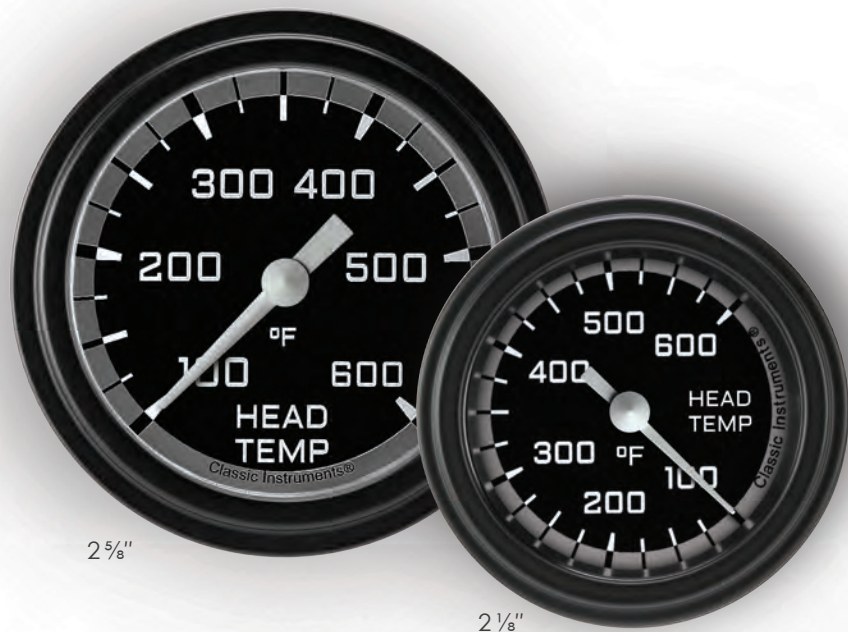

2 5/8"

2 1/8"

2 1/8" Full-sweep Cylinder Head Temp. Gauge  
2 5/8" Full-sweep Cylinder Head Temp. Gauge  
All seven series



Visit us online or call for details and order placement.  
[classicinstruments.com](http://classicinstruments.com) | 800.575.0461

2 1/8" Full-sweep Exhaust Gas Temp. Gauge  
2 5/8" Full-sweep Exhaust Gas Temp. Gauge  
All seven series





## Outside Air Temperature Gauges

Available



2 1/8" Full-sweep Outside Air Temp. Gauge  
2 5/8" Full-sweep Outside Air Temp. Gauge  
All seven series

Visit us online or call for details and order placement.  
[classicinstruments.com](http://classicinstruments.com) | 800.575.0461

## Matching Speedometers & Tachometers

Complete your dash with the many options we have for a matching speedometer and tachometer, each option is available in all seven series.

200 KPH upgrade option available on all styles and sizes.

3  $\frac{3}{8}$ " Speedometer 140, 160, 200 MPH

Standard MPH varies by style, see p. 35-36 for details

3  $\frac{3}{8}$ " Tachometer, 10,000 RPM

3  $\frac{3}{8}$ " Ultimate, speedo & tach combined

4  $\frac{5}{8}$ " Speedometer, 140, 160, 200 MPH

Standard MPH varies by style, see p. 35-36 for details

4  $\frac{5}{8}$ " Tachometer, 10,000 RPM

4  $\frac{5}{8}$ " Speedtachular, speedo & tach combined



3  $\frac{3}{8}$ " Tachometer



4  $\frac{5}{8}$ " Speedometer

## Three Gauge Sets

2 1/8" Short-sweep, Oil Pressure, Temp, Volt  
2 1/8" Full-sweep, Oil Pressure, Temp, Volt  
2 5/8" Short-sweep, Oil Pressure, Temp, Volt  
2 5/8" Full-sweep, Oil Pressure, Temp, Volt  
Available in all seven series  
Kit includes mounting bracket  
and all necessary sending units

See part number index, pg. 39  
for complete list of available options



2 1/8"

Both sizes also available in  
short-sweep instruments

Visit us online or call for details and order placement.  
[classicinstruments.com](http://classicinstruments.com) | 800.575.0461





2 5/8"



All necessary sending units are included with each set



## Five & Six Gauge Sets

Full-sweep, short-sweep, two speedometer and tach sizes and two sizes for the auxiliary gauges are the options you have to choose from when selecting your complete gauge set. See page 39 for all possible combinations and configurations. Sets are available in all seven performance series designs and don't forget, our custom shop can help you make it your very own!

All necessary sending units are included with each set

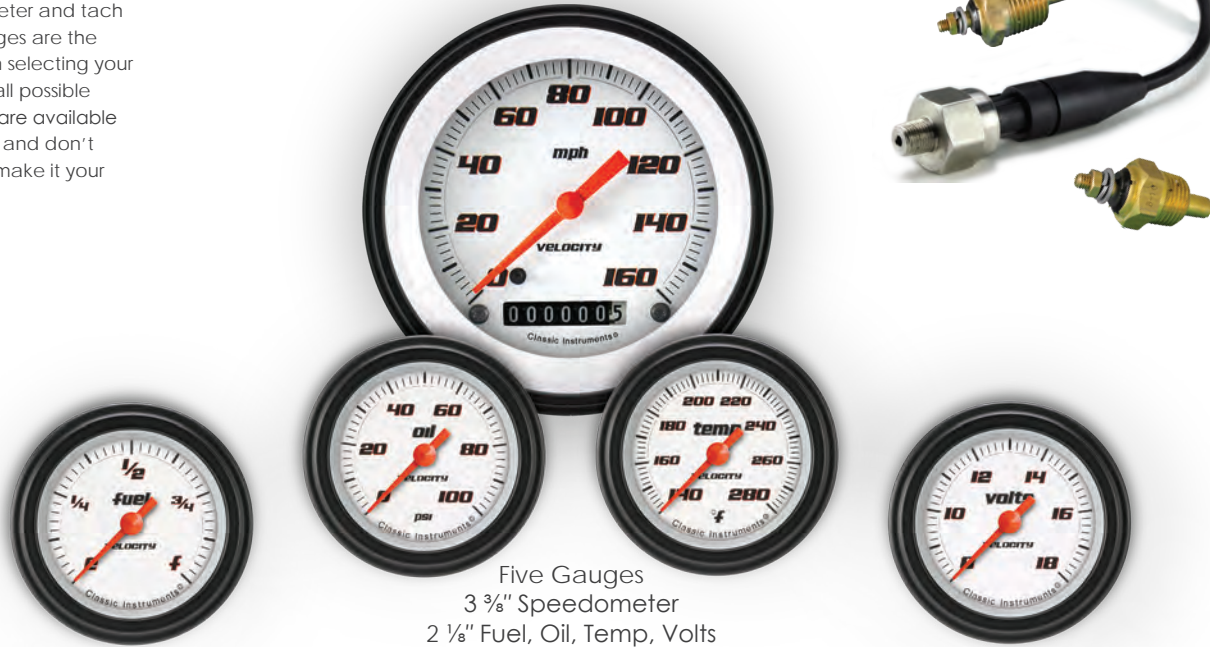

Five Gauges  
3 3/8" Speedometer  
2 1/8" Fuel, Oil, Temp, Volts  
part no. VS100WBLF

Visit us online or call for details and order placement.  
[classicinstruments.com](http://classicinstruments.com) | 800.575.0461



Six Gauges  
4  $\frac{5}{8}$ " Speedometer & Tach  
2  $\frac{5}{8}$ " Fuel, Oil, Temp, Volts  
part no. GS301SLF

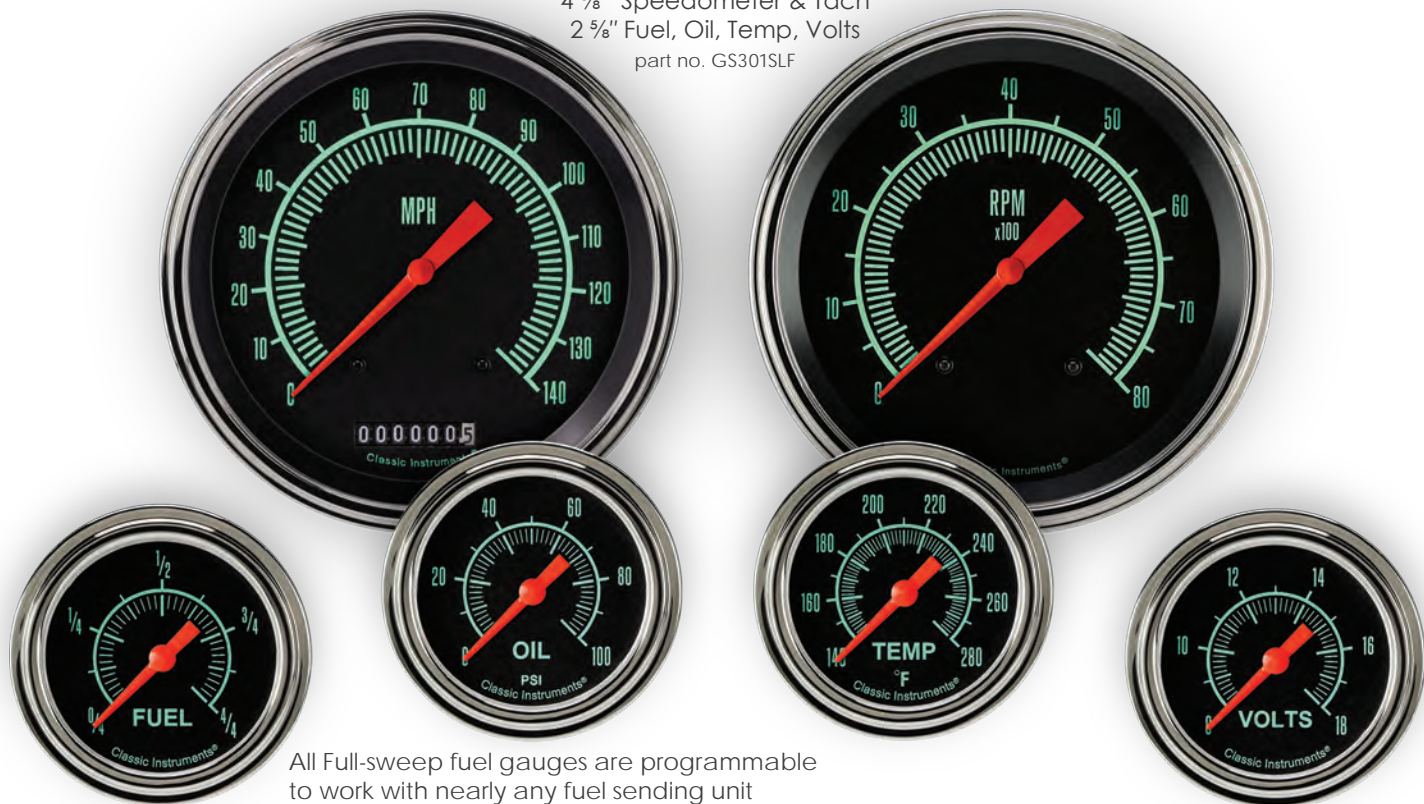

All Full-sweep fuel gauges are programmable to work with nearly any fuel sending unit



# Sending Units

## Temperature Sending Units

All Classic Instruments' temperature gauges require a Classic Instruments supplied sending unit for correct and reliable operation. All senders are equipped with self sealing, tapered threads, and are available in 1/8", 1/4", 3/8", 1/2" NPT and 12mm to fit most stock and after-market intake manifolds. Our outside air temperature gauges and low temperature gauges come with a stainless steel temperature probe.



## Oil Pressure Sending Units & Pressure Transducer

The oil pressure sending units supplied by Classic Instruments provide accurate pointer movement in adverse conditions such as heat, vibration, and acceleration. Anodized steel construction uses 1/8" NPT threads. Standard ohm range, 240-33, is available in 0-100 psi and 0-80 psi ranges. Also available is a Ford (A) oil pressure sending unit bushing kit for converting a 1/8" NPT sender outlet to a 1/4" NPT sender outlet and a GM (B) bushing kit which may be necessary for installation of an oil pressure sending unit on some GM engines.



Short-sweep pressure sender



Full-sweep pressure transducer

## Bosch Wideband sending unit with FAST™ controller

All Classic Instruments' Wideband Air/Fuel Ratio gauges come complete with a Bosch sensor and FAST™ controller.





2 1/8" Tach Cup  
Chrome



2 1/8" Tach Cup  
Matte Black



3 5/8" Tach Cup  
Chrome



3 5/8" Tach Cup  
Matte Black



Under Dash Panel  
Two 2 1/8" holes



Under Dash Panel  
Three 2 1/8" holes



Under Dash Panel  
Two 2 5/8" holes



Under Dash Panel  
Three 2 5/8" holes

# Dimensions

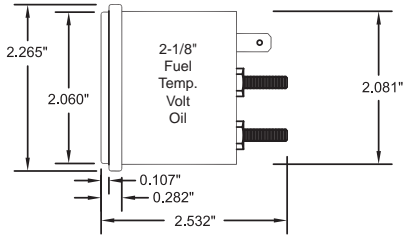

2 1/8" Short-sweep Gauges

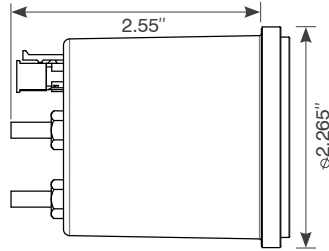

2 1/8" Full-sweep Gauges

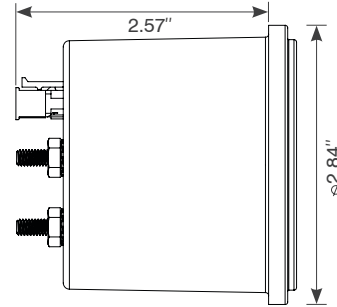

All 2 5/8" Gauges

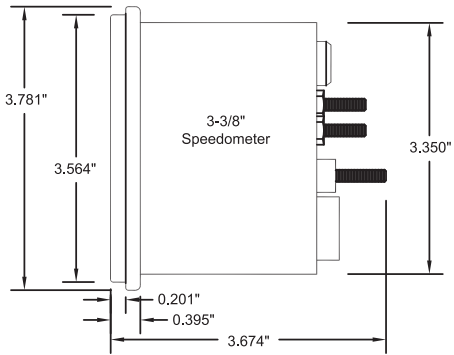

3 3/8" Speedometer

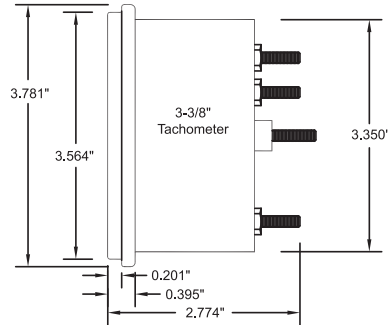

3 3/8" Tachometer

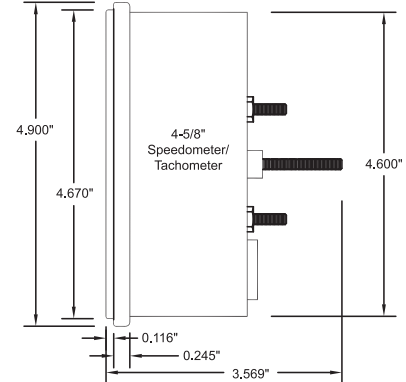

4 5/8" Speedometer / Tachometer



## Fuel Gauges

\*Programmable ohm range

### AutoCross Gray

AX09GBLF ..... 2 1/8" Short-sweep Fuel Gauge, 240-33 ohm  
 AX11GBLF ..... 2 1/8" Short-sweep Fuel Gauge, 75-10 ohm  
 AX12GBLF ..... 2 1/8" Short-sweep Fuel Gauge, 0-90 ohm  
 AX13GBLF ..... 2 1/8" Short-sweep Fuel Gauge, 16-158 ohm  
 AX14GBLF ..... 2 1/8" Short-sweep Fuel Gauge, 0-30 ohm  
 AX109GBLF ..... 2 1/8" Full-sweep Fuel Gauge\*  
 AX209GBLF ..... 2 5/8" Short-sweep Fuel Gauge, 240-33 ohm  
 AX211GBLF ..... 2 5/8" Short-sweep Fuel Gauge, 75-10 ohm  
 AX212GBLF ..... 2 5/8" Short-sweep Fuel Gauge, 0-90 ohm  
 AX309GBLF ..... 2 5/8" Full-sweep Fuel Gauge\*

--With Performance Bezel--

AX209GAPF ..... 2 5/8" Short-sweep, Aluminum, 240-33 ohm  
 AX209GBPF ..... 2 5/8" Short-sweep, Black, 240-33 ohm  
 AX211GAPF ..... 2 5/8" Short-sweep, Aluminum, 75-10 ohm  
 AX211GBPF ..... 2 5/8" Short-sweep, Black, 75-10 ohm  
 AX212GAPF ..... 2 5/8" Short-sweep, Aluminum, 0-90 ohm  
 AX212GBPF ..... 2 5/8" Short-sweep, Black, 0-90 ohm  
 AX309GAPF ..... 2 5/8" Full-sweep Fuel Gauge, Aluminum\*  
 AX309GBPF ..... 2 5/8" Full-sweep Fuel Gauge, Black\*

### AutoCross Yellow

AX09YBLF ..... 2 1/8" Short-sweep Fuel Gauge, 240-33 ohm  
 AX11YBLF ..... 2 1/8" Short-sweep Fuel Gauge, 75-10 ohm  
 AX12YBLF ..... 2 1/8" Short-sweep Fuel Gauge, 0-90 ohm  
 AX13YBLF ..... 2 1/8" Short-sweep Fuel Gauge, 16-158 ohm  
 AX14YBLF ..... 2 1/8" Short-sweep Fuel Gauge, 0-30 ohm  
 AX109YBLF ..... 2 1/8" Full-sweep Fuel Gauge\*  
 AX209YBLF ..... 2 5/8" Short-sweep Fuel Gauge, 240-33 ohm  
 AX211YBLF ..... 2 5/8" Short-sweep Fuel Gauge, 75-10 ohm  
 AX212YBLF ..... 2 5/8" Short-sweep Fuel Gauge, 0-90 ohm  
 AX309YBLF ..... 2 5/8" Full-sweep Fuel Gauge\*

--With Performance Bezel--

AX209YAPF ..... 2 5/8" Short-sweep, Aluminum, 240-33 ohm  
 AX209YBPF ..... 2 5/8" Short-sweep, Black, 240-33 ohm  
 AX211YAPF ..... 2 5/8" Short-sweep, Aluminum, 75-10 ohm  
 AX211YBPF ..... 2 5/8" Short-sweep, Black, 75-10 ohm  
 AX212YAPF ..... 2 5/8" Short-sweep, Aluminum, 0-90 ohm

AX212YBPF ..... 2 5/8" Short-sweep, Black, 0-90 ohm  
 AX309YAPF ..... 2 5/8" Full-sweep, Aluminum\*  
 AX309YBPF ..... 2 5/8" Full-sweep, Black\*

### G-Stock

GS09SLF ..... 2 1/8" Short-sweep Fuel Gauge, 240-33 ohm  
 GS11SLF ..... 2 1/8" Short-sweep Fuel Gauge, 75-10 ohm  
 GS12SLF ..... 2 1/8" Short-sweep Fuel Gauge, 0-90 ohm  
 GS13SLF ..... 2 1/8" Short-sweep Fuel Gauge, 16-158 ohm  
 GS14SLF ..... 2 1/8" Short-sweep Fuel Gauge, 0-30 ohm  
 GS109SLF ..... 2 1/8" Full-sweep Fuel Gauge\*  
 GS209SLF ..... 2 5/8" Short-sweep Fuel Gauge, 240-33 ohm  
 GS211SLF ..... 2 5/8" Short-sweep Fuel Gauge, 75-10 ohm  
 GS212SLF ..... 2 5/8" Short-sweep Fuel Gauge, 0-90 ohm  
 GS309SLF ..... 2 5/8" Full-sweep Fuel Gauge\*

### Hot Rod

HR09SLF ..... 2 1/8" Short-sweep Fuel Gauge, 240-33 ohm  
 HR11SLF ..... 2 1/8" Short-sweep Fuel Gauge, 75-10 ohm  
 HR12SLF ..... 2 1/8" Short-sweep Fuel Gauge, 0-90 ohm  
 HR13SLF ..... 2 1/8" Short-sweep Fuel Gauge, 16-158 ohm  
 HR14SLF ..... 2 1/8" Short-sweep Fuel Gauge, 0-30 ohm  
 HR109SLF ..... 2 1/8" Full-sweep Fuel Gauge\*  
 HR209SLF ..... 2 5/8" Short-sweep Fuel Gauge, 240-33 ohm  
 HR211SLF ..... 2 5/8" Short-sweep Fuel Gauge, 75-10 ohm  
 HR212SLF ..... 2 5/8" Short-sweep Fuel Gauge, 0-90 ohm  
 HR309SLF ..... 2 5/8" Full-sweep Fuel Gauge\*

### Velocity Black

VS09BBLF ..... 2 1/8" Short-sweep Fuel Gauge, 240-33 ohm  
 VS11BBLF ..... 2 1/8" Short-sweep Fuel Gauge, 75-10 ohm  
 VS12BBLF ..... 2 1/8" Short-sweep Fuel Gauge, 0-90 ohm  
 VS13BBLF ..... 2 1/8" Short-sweep Fuel Gauge, 16-158 ohm  
 VS14BBLF ..... 2 1/8" Short-sweep Fuel Gauge, 0-30 ohm  
 VS109BBLF ..... 2 1/8" Full-sweep Fuel Gauge\*  
 VS209BBLF ..... 2 5/8" Short-sweep Fuel Gauge, 240-33 ohm  
 VS211BBLF ..... 2 5/8" Short-sweep Fuel Gauge, 75-10 ohm  
 VS212BBLF ..... 2 5/8" Short-sweep Fuel Gauge, 0-90 ohm  
 VS309BBLF ..... 2 5/8" Full-sweep Fuel Gauge\*

--With Performance Bezel--

VS209BAPF ..... 2 5/8" Short-sweep, Aluminum, 240-33 ohm  
 VS209BBPF ..... 2 5/8" Short-sweep, Black, 240-33 ohm

VS211BAPF ..... 2 5/8" Short-sweep, Aluminum, 75-10 ohm  
 VS211BBPF ..... 2 5/8" Short-sweep, Black, 75-10 ohm  
 VS212BAPF ..... 2 5/8" Short-sweep, Aluminum, 0-90 ohm  
 VS212BBPF ..... 2 5/8" Short-sweep, Black, 0-90 ohm  
 VS309BAPF ..... 2 5/8" Full-sweep Fuel Gauge, Aluminum\*  
 VS309BBPF ..... 2 5/8" Full-sweep Fuel Gauge, Black\*

### Velocity White

VS09WBLF ..... 2 1/8" Short-sweep Fuel Gauge, 240-33 ohm  
 VS11WBLF ..... 2 1/8" Short-sweep Fuel Gauge, 75-10 ohm  
 VS12WBLF ..... 2 1/8" Short-sweep Fuel Gauge, 0-90 ohm  
 VS13WBLF ..... 2 1/8" Short-sweep Fuel Gauge, 16-158 ohm  
 VS14WBLF ..... 2 1/8" Short-sweep Fuel Gauge, 0-30 ohm  
 VS109WBLF ..... 2 1/8" Full-sweep Fuel Gauge\*  
 VS209WBLF ..... 2 5/8" Short-sweep Fuel Gauge, 240-33 ohm  
 VS211WBLF ..... 2 5/8" Short-sweep Fuel Gauge, 75-10 ohm  
 VS212WBLF ..... 2 5/8" Short-sweep Fuel Gauge, 0-90 ohm  
 VS309WBLF ..... 2 5/8" Full-sweep Fuel Gauge\*

--With Performance Bezel--

VS209WAPF ..... 2 5/8" Short-sweep, Aluminum, 240-33 ohm  
 VS209WBPF ..... 2 5/8" Short-sweep, Black, 240-33 ohm  
 VS211WAPF ..... 2 5/8" Short-sweep, Aluminum, 75-10 ohm  
 VS211WBPF ..... 2 5/8" Short-sweep, Black, 75-10 ohm  
 VS212WAPF ..... 2 5/8" Short-sweep, Aluminum, 0-90 ohm  
 VS212WBPF ..... 2 5/8" Short-sweep, Black, 0-90 ohm  
 VS309WAPF ..... 2 5/8" Full-sweep Fuel Gauge, Aluminum\*  
 VS309WBPF ..... 2 5/8" Full-sweep Fuel Gauge, Black\*

### White Hot

WH09SLF ..... 2 1/8" Short-sweep Fuel Gauge, 240-33 ohm  
 WH11SLF ..... 2 1/8" Short-sweep Fuel Gauge, 75-10 ohm  
 WH12SLF ..... 2 1/8" Short-sweep Fuel Gauge, 0-90 ohm  
 WH13SLF ..... 2 1/8" Short-sweep Fuel Gauge, 16-158 ohm  
 WH14SLF ..... 2 1/8" Short-sweep Fuel Gauge, 0-30 ohm  
 WH109SLF ..... 2 1/8" Full-sweep Fuel Gauge\*  
 WH209SLF ..... 2 5/8" Short-sweep Fuel Gauge, 240-33 ohm  
 WH211SLF ..... 2 5/8" Short-sweep Fuel Gauge, 75-10 ohm  
 WH212SLF ..... 2 5/8" Short-sweep Fuel Gauge, 0-90 ohm  
 WH309SLF ..... 2 5/8" Full-sweep Fuel Gauge\*

# Part Number Index

## Air Pressure Gauges

### AutoCross Gray

AX118GBLF..... 2 1/8" Full-sweep Air Pressure Gauge

AX318GBLF .... 2 5/8" Full-sweep Air Pressure Gauge

--With Performance Bezel--

AX318GAPF ... 2 5/8" Full-sweep Air Pressure Gauge, Aluminum

AX318GBPF.... 2 5/8" Full-sweep Air Pressure Gauge, Black

### AutoCross Yellow

AX118YBLF ..... 2 1/8" Full-sweep Air Pressure Gauge

AX318YBLF ..... 2 5/8" Full-sweep Air Pressure Gauge

--With Performance Bezel--

AX318YAPF..... 2 5/8" Full-sweep Air Pressure Gauge, Aluminum

AX318YBPF..... 2 5/8" Full-sweep Air Pressure Gauge, Black

### G-Stock

GS118SLF ..... 2 1/8" Full-sweep Air Pressure Gauge

GS318SLF..... 2 5/8" Full-sweep Air Pressure Gauge

### Hot Rod

HR118SLF ..... 2 1/8" Full-sweep Air Pressure Gauge

HR318SLF ..... 2 5/8" Full-sweep Air Pressure Gauge

### Velocity Black

VS118BBLF ..... 2 1/8" Full-sweep Air Pressure Gauge

VS318BBLF ..... 2 5/8" Full-sweep Air Pressure Gauge

--With Performance Bezel--

VS318BAPF..... 2 5/8" Full-sweep Air Pressure Gauge, Aluminum

VS318BBPF ..... 2 5/8" Full-sweep Air Pressure Gauge, Black

### Velocity White

VS118WBLF ..... 2 1/8" Full-sweep Air Pressure Gauge

VS318WBLF..... 2 5/8" Full-sweep Air Pressure Gauge

--With Performance Bezel--

VS318WAPF.... 2 5/8" Full-sweep Air Pressure Gauge, Aluminum

VS318WBPF ..... 2 5/8" Full-sweep Air Pressure Gauge, Black

### White Hot

WH118SLF ..... 2 1/8" Full-sweep Air Pressure Gauge

WH318SLF..... 2 5/8" Full-sweep Air Pressure Gauge

## Water Temperature Gauges

Sender purchased separately on 2 1/8" short-sweep gauges

\*Add code for sender size:

02 = 1/8" Temp sender

04 = 1/4" Temp sender

06 = 3/8" Temp sender

08 = 1/2" Temp sender

12 = 12mm Temp sender

### AutoCross Gray

AX26GBLF..... 2 1/8" Short-sweep Water Temp. Gauge

AX126GBLF.\* 2 1/8" Full-sweep Water Temp. Gauge

AX226GBLF.\* 2 5/8" Short-sweep Water Temp. Gauge

AX326GBLF.\* 2 5/8" Full-sweep Water Temp. Gauge

--With Performance Bezel--

AX226GAPF.\* 2 5/8" Short-sweep Water Temp. Gauge, Aluminum

AX226GBPF.\* 2 5/8" Short-sweep Water Temp. Gauge, Black

AX326GAPF.\* 2 5/8" Full-sweep Water Temp. Gauge, Aluminum

AX326GBPF.\* 2 5/8" Full-sweep Water Temp. Gauge, Black

### AutoCross Yellow

AX26YBLF ..... 2 1/8" Short-sweep Water Temp. Gauge

AX126YBLF.\* 2 1/8" Full-sweep Water Temp. Gauge

AX226YBLF.\* 2 5/8" Short-sweep Water Temp. Gauge

AX326YBLF.\* 2 5/8" Full-sweep Water Temp. Gauge

--With Performance Bezel--

AX226YAPF.\* 2 5/8" Short-sweep Water Temp. Gauge, Aluminum

AX226YBPF.\* 2 5/8" Short-sweep Water Temp. Gauge, Black

AX326YAPF.\* 2 5/8" Full-sweep Water Temp. Gauge, Aluminum

AX326YBPF.\* 2 5/8" Full-sweep Water Temp. Gauge, Black

### G-Stock

GS26SLF..... 2 1/8" Short-sweep Water Temp. Gauge

GS126SLF.\* ..... 2 1/8" Full-sweep Water Temp. Gauge

GS226SLF.\* ..... 2 5/8" Short-sweep Water Temp. Gauge

GS326SLF.\* ..... 2 5/8" Full-sweep Water Temp. Gauge

### Hot Rod

HR26SLF..... 2 1/8" Short-sweep Water Temp. Gauge

HR126SLF.\* ..... 2 1/8" Full-sweep Water Temp. Gauge

HR226SLF.\* ..... 2 5/8" Short-sweep Water Temp. Gauge

HR326SLF.\* ..... 2 5/8" Full-sweep Water Temp. Gauge

## Velocity Black

VS26BBLF..... 2 1/8" Short-sweep Water Temp. Gauge

VS126BBLF-.\* ..... 2 1/8" Full-sweep Water Temp. Gauge

VS226BBLF-.\* ..... 2 5/8" Short-sweep Water Temp. Gauge

VS326BBLF-.\* ..... 2 5/8" Full-sweep Water Temp. Gauge

--With Performance Bezel--

VS226BAPF-.\* ..... 2 5/8" Short-sweep Water Temp. Gauge, Aluminum

VS226BBPF-.\* ..... 2 5/8" Short-sweep Water Temp. Gauge, Black

VS326BAPF-.\* ..... 2 5/8" Full-sweep Water Temp. Gauge, Aluminum

VS326BBPF-.\* ..... 2 5/8" Full-sweep Water Temp. Gauge, Black

## Velocity White

VS26WBLF..... 2 1/8" Short-sweep Water Temp. Gauge

VS126WBLF-.\* 2 1/8" Full-sweep Water Temp. Gauge

VS226WBLF-.\* 2 5/8" Short-sweep Water Temp. Gauge

VS326WBLF-.\* 2 5/8" Full-sweep Water Temp. Gauge

--With Performance Bezel--

VS226WAPF-.\* 2 5/8" Short-sweep Water Temp. Gauge, Aluminum

VS226WBPF-.\* 2 5/8" Short-sweep Water Temp. Gauge, Black

VS326WAPF-.\* 2 5/8" Full-sweep Water Temp. Gauge, Aluminum

VS326WBPF-.\* 2 5/8" Full-sweep Water Temp. Gauge, Black

## White Hot

WH26SLF..... 2 1/8" Short-sweep Water Temp. Gauge

WH126SLF-.\* ..... 2 1/8" Full-sweep Water Temp. Gauge

WH226SLF-.\* ..... 2 5/8" Short-sweep Water Temp. Gauge

WH326SLF-.\* ..... 2 5/8" Full-sweep Water Temp. Gauge

## Transmission Temperature Gauges

Sender purchased separately on 2 1/8" short-sweep gauges

### AutoCross Gray

AX27GBLF ..... 2 1/8" Short-sweep Trans. Temp. Gauge

AX127GBLF .... 2 1/8" Full-sweep Trans. Temp. Gauge

AX227GBLF .... 2 5/8" Short-sweep Trans. Temp. Gauge

AX327GBLF .... 2 5/8" Full-sweep Trans. Temp. Gauge

--With Performance Bezel--

AX227GAPF .. 2 5/8" Short-sweep Trans. Temp. Gauge, Aluminum

AX227GBPF .. 2 5/8" Short-sweep Trans. Temp. Gauge, Black

AX327GAPF .. 2 5/8" Full-sweep Trans. Temp. Gauge, Aluminum

AX327GBPF.... 2 5/8" Full-sweep Trans. Temp. Gauge, Black

### AutoCross Yellow

AX27YBLF ..... 2 1/8" Short-sweep Trans. Temp. Gauge  
AX127YBLF ..... 2 1/8" Full-sweep Trans. Temp. Gauge  
AX227YBLF ..... 2 5/8" Short-sweep Trans. Temp. Gauge  
AX327YBLF ..... 2 5/8" Full-sweep Trans. Temp. Gauge

--With Performance Bezel--

AX227YAPF ..... 2 5/8" Short-sweep Trans. Temp. Gauge, Aluminum  
AX227YBPF ..... 2 5/8" Short-sweep Trans. Temp. Gauge, Black  
AX327YAPF ..... 2 5/8" Full-sweep Trans. Temp. Gauge, Aluminum  
AX327YBPF ..... 2 5/8" Full-sweep Trans. Temp. Gauge, Black

### G-Stock

GS27SLF ..... 2 1/8" Short-sweep Trans. Temp. Gauge  
GS127SLF ..... 2 1/8" Full-sweep Trans. Temp. Gauge  
GS227SLF ..... 2 5/8" Short-sweep Trans. Temp. Gauge  
GS327SLF ..... 2 5/8" Full-sweep Trans. Temp. Gauge

### Hot Rod

HR27SLF ..... 2 1/8" Short-sweep Trans. Temp. Gauge  
HR127SLF ..... 2 1/8" Full-sweep Trans. Temp. Gauge  
HR227SLF ..... 2 5/8" Short-sweep Trans. Temp. Gauge  
HR327SLF ..... 2 5/8" Full-sweep Trans. Temp. Gauge

### Velocity Black

VS27BBLF ..... 2 1/8" Short-sweep Trans. Temp. Gauge  
VS127BBLF ..... 2 1/8" Full-sweep Trans. Temp. Gauge  
VS227BBLF ..... 2 5/8" Short-sweep Trans. Temp. Gauge  
VS327BBLF ..... 2 5/8" Full-sweep Trans. Temp. Gauge

--With Performance Bezel--

VS227BAPF ..... 2 5/8" Short-sweep Trans. Temp. Gauge, Aluminum  
VS227BBPF ..... 2 5/8" Short-sweep Trans. Temp. Gauge, Black  
VS327BAPF ..... 2 5/8" Full-sweep Trans. Temp. Gauge, Aluminum  
VS327BBPF ..... 2 5/8" Full-sweep Trans. Temp. Gauge, Black

### Velocity White

VS27WBLF ..... 2 1/8" Short-sweep Trans. Temp. Gauge  
VS127WBLF ..... 2 1/8" Full-sweep Trans. Temp. Gauge  
VS227WBLF ..... 2 5/8" Short-sweep Trans. Temp. Gauge  
VS327WBLF ..... 2 5/8" Full-sweep Trans. Temp. Gauge

--With Performance Bezel--

VS227WAPF ..... 2 5/8" Short-sweep Trans. Temp. Gauge, Aluminum  
VS227WBPF ..... 2 5/8" Short-sweep Trans. Temp. Gauge, Black  
VS327WAPF ..... 2 5/8" Full-sweep Trans. Temp. Gauge, Aluminum  
VS327WBPF ..... 2 5/8" Full-sweep Trans. Temp. Gauge, Black

### White Hot

WH27SLF ..... 2 1/8" Short-sweep Trans. Temp. Gauge  
WH127SLF ..... 2 1/8" Full-sweep Trans. Temp. Gauge  
WH227SLF ..... 2 5/8" Short-sweep Trans. Temp. Gauge  
WH327SLF ..... 2 5/8" Full-sweep Trans. Temp. Gauge

### Oil Temperature Gauges

Sender purchased separately on 2 1/8" short-sweep gauges

#### AutoCross Gray

AX28GBLF ..... 2 1/8" Short-sweep Oil Temp. Gauge  
AX128GBLF ..... 2 1/8" Full-sweep Oil Temp. Gauge  
AX228GBLF ..... 2 5/8" Short-sweep Oil Temp. Gauge  
AX328GBLF ..... 2 5/8" Full-sweep Oil Temp. Gauge

--With Performance Bezel--

AX228GAPF ..... 2 5/8" Short-sweep Oil Temp. Gauge, Aluminum  
AX228GBPF ..... 2 5/8" Short-sweep Oil Temp. Gauge, Black  
AX328GAPF ..... 2 5/8" Full-sweep Oil Temp. Gauge, Aluminum  
AX328GBPF ..... 2 5/8" Full-sweep Oil Temp. Gauge, Black

#### AutoCross Yellow

AX28YBLF ..... 2 1/8" Short-sweep Oil Temp. Gauge  
AX128YBLF ..... 2 1/8" Full-sweep Oil Temp. Gauge  
AX228YBLF ..... 2 5/8" Short-sweep Oil Temp. Gauge  
AX328YBLF ..... 2 5/8" Full-sweep Oil Temp. Gauge

--With Performance Bezel--

AX228YAPF ..... 2 5/8" Short-sweep Oil Temp. Gauge, Aluminum  
AX228YBPF ..... 2 5/8" Short-sweep Oil Temp. Gauge, Black  
AX328YAPF ..... 2 5/8" Full-sweep Oil Temp. Gauge, Aluminum  
AX328YBPF ..... 2 5/8" Full-sweep Oil Temp. Gauge, Black

### G-Stock

GS28SLF ..... 2 1/8" Short-sweep Oil Temp. Gauge  
GS128SLF ..... 2 1/8" Full-sweep Oil Temp. Gauge  
GS228SLF ..... 2 5/8" Short-sweep Oil Temp. Gauge  
GS328SLF ..... 2 5/8" Full-sweep Oil Temp. Gauge

### Hot Rod

HR28SLF ..... 2 1/8" Short-sweep Oil Temp. Gauge  
HR128SLF ..... 2 1/8" Full-sweep Oil Temp. Gauge  
HR228SLF ..... 2 5/8" Short-sweep Oil Temp. Gauge  
HR328SLF ..... 2 5/8" Full-sweep Oil Temp. Gauge

### Velocity Black

VS28BBLF ..... 2 1/8" Short-sweep Oil Temp. Gauge  
VS128BBLF ..... 2 1/8" Full-sweep Oil Temp. Gauge  
VS228BBLF ..... 2 5/8" Short-sweep Oil Temp. Gauge  
VS328BBLF ..... 2 5/8" Full-sweep Oil Temp. Gauge

--With Performance Bezel--

VS228BAPF ..... 2 5/8" Short-sweep Oil Temp. Gauge, Aluminum  
VS228BBPF ..... 2 5/8" Short-sweep Oil Temp. Gauge, Black  
VS328BAPF ..... 2 5/8" Full-sweep Oil Temp. Gauge, Aluminum  
VS328BBPF ..... 2 5/8" Full-sweep Oil Temp. Gauge, Black

### Velocity White

VS28WBLF ..... 2 1/8" Short-sweep Oil Temp. Gauge  
VS128WBLF ..... 2 1/8" Full-sweep Oil Temp. Gauge  
VS228WBLF ..... 2 5/8" Short-sweep Oil Temp. Gauge  
VS328WBLF ..... 2 5/8" Full-sweep Oil Temp. Gauge

--With Performance Bezel--

VS228WAPF ..... 2 5/8" Short-sweep Oil Temp. Gauge, Aluminum  
VS228WBPF ..... 2 5/8" Short-sweep Oil Temp. Gauge, Black  
VS328WAPF ..... 2 5/8" Full-sweep Oil Temp. Gauge, Aluminum  
VS328WBPF ..... 2 5/8" Full-sweep Oil Temp. Gauge, Black

### White Hot

WH28SLF ..... 2 1/8" Short-sweep Oil Temp. Gauge  
WH128SLF ..... 2 1/8" Full-sweep Oil Temp. Gauge  
WH228SLF ..... 2 5/8" Short-sweep Oil Temp. Gauge  
WH328SLF ..... 2 5/8" Full-sweep Oil Temp. Gauge

### Stock Eliminator Temperature Gauges

#### AutoCross Gray

AX129GBLF ..... 2 1/8" Full-sweep Stock Eliminator Temp. Gauge  
AX329GBLF ..... 2 5/8" Full-sweep Stock Eliminator Temp. Gauge  
--With Performance Bezel--  
AX329GAPF ..... 2 5/8" Full-sweep Stock Eliminator Temp., Aluminum  
AX329GBPF ..... 2 5/8" Full-sweep Stock Eliminator Temp., Black

#### AutoCross Yellow

AX129YBLF ..... 2 1/8" Full-sweep Stock Eliminator Temp. Gauge  
AX329YBLF ..... 2 5/8" Full-sweep Stock Eliminator Temp. Gauge  
--With Performance Bezel--  
AX329YAPF ..... 2 5/8" Full-sweep Stock Eliminator Temp., Aluminum  
AX329YBPF ..... 2 5/8" Full-sweep Stock Eliminator Temp., Black



# Part Number Index

## G-Stock

GS129SLF ..... 2 1/8" Full-sweep Stock Eliminator Temp. Gauge  
GS329SLF ..... 2 5/8" Full-sweep Stock Eliminator Temp. Gauge

## Hot Rod

HR129SLF ..... 2 1/8" Full-sweep Stock Eliminator Temp. Gauge  
HR329SLF ..... 2 5/8" Full-sweep Stock Eliminator Temp. Gauge

## Velocity Black

VS129BBLF ..... 2 1/8" Full-sweep Stock Eliminator Temp. Gauge  
VS329BBLF ..... 2 5/8" Full-sweep Stock Eliminator Temp. Gauge

## --With Performance Bezel--

VS329BAPF ..... 2 5/8" Full-sweep Stock Elimin. Temp., Aluminum  
VS329BBPF ..... 2 5/8" Full-sweep Stock Eliminator Temp., Black

## Velocity White

VS129WBLF ..... 2 1/8" Full-sweep Stock Eliminator Temp. Gauge  
VS329WBLF ..... 2 5/8" Full-sweep Stock Eliminator Temp. Gauge

## --With Performance Bezel--

VS329WAPF ..... 2 5/8" Full-sweep Stock Eliminator Temp., Aluminum  
VS329WBPF ..... 2 5/8" Full-sweep Stock Eliminator Temp., Black

## White Hot

WH129SLF ..... 2 1/8" Full-sweep Stock Eliminator Temp. Gauge  
WH329SLF ..... 2 5/8" Full-sweep Stock Eliminator Temp. Gauge

## Volt Gauges

### AutoCross Gray

AX30GBLF ..... 2 1/8" Short-sweep Volt Gauge  
AX130GBLF ..... 2 1/8" Full-sweep Volt Gauge  
AX230GBLF ..... 2 5/8" Short-sweep Volt Gauge  
AX330GBLF ..... 2 5/8" Full-sweep Volt Gauge

### --With Performance Bezel--

AX230GAPF ..... 2 5/8" Short-sweep Volt Gauge, Aluminum  
AX230GBPF ..... 2 5/8" Short-sweep Volt Gauge, Black  
AX330GAPF ..... 2 5/8" Full-sweep Volt Gauge, Aluminum  
AX330GBPF ..... 2 5/8" Full-sweep Volt Gauge, Black

### AutoCross Yellow

AX30YBLF ..... 2 1/8" Short-sweep Volt Gauge  
AX130YBLF ..... 2 1/8" Full-sweep Volt Gauge  
AX230YBLF ..... 2 5/8" Short-sweep Volt Gauge  
AX330YBLF ..... 2 5/8" Full-sweep Volt Gauge

### --With Performance Bezel--

AX230YAPF ..... 2 5/8" Short-sweep Volt Gauge, Aluminum  
AX230YBPF ..... 2 5/8" Short-sweep Volt Gauge, Black  
AX330YAPF ..... 2 5/8" Full-sweep Volt Gauge, Aluminum  
AX330YBPF ..... 2 5/8" Full-sweep Volt Gauge, Black

## G-Stock

GS30SLF ..... 2 1/8" Short-sweep Volt Gauge  
GS130SLF ..... 2 1/8" Full-sweep Volt Gauge  
GS230SLF ..... 2 5/8" Short-sweep Volt Gauge  
GS330SLF ..... 2 5/8" Full-sweep Volt Gauge

## Hot Rod

HR30SLF ..... 2 1/8" Short-sweep Volt Gauge  
HR130SLF ..... 2 1/8" Full-sweep Volt Gauge  
HR230SLF ..... 2 5/8" Short-sweep Volt Gauge  
HR330SLF ..... 2 5/8" Full-sweep Volt Gauge

## Velocity Black

VS30BBLF ..... 2 1/8" Short-sweep Volt Gauge  
VS130BBLF ..... 2 1/8" Full-sweep Volt Gauge  
VS230BBLF ..... 2 5/8" Short-sweep Volt Gauge  
VS330BBLF ..... 2 5/8" Full-sweep Volt Gauge

### --With Performance Bezel--

VS230BAPF ..... 2 5/8" Short-sweep Volt Gauge, Aluminum  
VS230BBPF ..... 2 5/8" Short-sweep Volt Gauge, Black  
VS330BAPF ..... 2 5/8" Full-sweep Volt Gauge, Aluminum  
VS330BBPF ..... 2 5/8" Full-sweep Volt Gauge, Black

## Velocity White

VS30WBLF ..... 2 1/8" Short-sweep Volt Gauge  
VS130WBLF ..... 2 1/8" Full-sweep Volt Gauge  
VS230WBLF ..... 2 5/8" Short-sweep Volt Gauge  
VS330WBLF ..... 2 5/8" Full-sweep Volt Gauge

### --With Performance Bezel--

VS230WAPF ..... 2 5/8" Short-sweep Volt Gauge, Aluminum  
VS230WBPF ..... 2 5/8" Short-sweep Volt Gauge, Black  
VS330WAPF ..... 2 5/8" Full-sweep Volt Gauge, Aluminum  
VS330WBPF ..... 2 5/8" Full-sweep Volt Gauge, Black

## White Hot

WH30SLF ..... 2 1/8" Short-sweep Volt Gauge  
WH130SLF ..... 2 1/8" Full-sweep Volt Gauge  
WH230SLF ..... 2 5/8" Short-sweep Volt Gauge  
WH330SLF ..... 2 5/8" Full-sweep Volt Gauge

## Boost/Vac Gauges

### AutoCross Gray

AX141GBLF ..... 2 1/8" Full-sweep Boost/Vac Gauge  
AX341GBLF ..... 2 5/8" Full-sweep Boost/Vac Gauge

### --With Performance Bezel--

AX341GAPF ..... 2 5/8" Full-sweep Boost/Vac Gauge, Aluminum  
AX341GBPF ..... 2 5/8" Full-sweep Boost/Vac Gauge, Black

### AutoCross Yellow

AX141YBLF ..... 2 1/8" Full-sweep Boost/Vac Gauge  
AX341YBLF ..... 2 5/8" Full-sweep Boost/Vac Gauge

### --With Performance Bezel--

AX341YAPF ..... 2 5/8" Full-sweep Boost/Vac Gauge, Aluminum  
AX341YBPF ..... 2 5/8" Full-sweep Boost/Vac Gauge, Black

## G-Stock

GS141SLF ..... 2 1/8" Full-sweep Boost/Vac Gauge  
GS341SLF ..... 2 5/8" Full-sweep Boost/Vac Gauge

## Hot Rod

HR141SLF ..... 2 1/8" Full-sweep Boost/Vac Gauge  
HR341SLF ..... 2 5/8" Full-sweep Boost/Vac Gauge

## Velocity Black

VS141BBLF ..... 2 1/8" Full-sweep Boost/Vac Gauge  
VS341BBLF ..... 2 5/8" Full-sweep Boost/Vac Gauge

### --With Performance Bezel--

VS341BAPF ..... 2 5/8" Full-sweep Boost/Vac Gauge, Aluminum  
VS341BBPF ..... 2 5/8" Full-sweep Boost/Vac Gauge, Black

## Velocity White

VS141WBLF ..... 2 1/8" Full-sweep Boost/Vac Gauge  
VS341WBLF ..... 2 5/8" Full-sweep Boost/Vac Gauge

### --With Performance Bezel--

VS341WAPF ..... 2 5/8" Full-sweep Boost/Vac Gauge, Aluminum  
VS341WBPF ..... 2 5/8" Full-sweep Boost/Vac Gauge, Black

## White Hot

WH141SLF ..... 2 1/8" Full-sweep Boost/Vac Gauge  
WH341SLF ..... 2 5/8" Full-sweep Boost/Vac Gauge

## Boost Gauges, 30 PSI

### AutoCross Gray

AX142GBLF ..... 2½" Full-sweep Boost 30PSI Gauge

AX342GBLF ..... 2½" Full-sweep Boost 30PSI Gauge

--With Performance Bezel--

AX342GAPF ... 2½" Full-sweep Boost 30PSI Gauge, Aluminum

AX342GBPF ... 2½" Full-sweep Boost 30PSI Gauge, Black

### AutoCross Yellow

AX142YBLF ..... 2½" Full-sweep Boost 30PSI Gauge

AX342YBLF ..... 2½" Full-sweep Boost 30PSI Gauge

--With Performance Bezel--

AX342YAPF ..... 2½" Full-sweep Boost 30PSI Gauge, Aluminum

AX342YBPF ..... 2½" Full-sweep Boost 30PSI Gauge, Black

### G-Stock

GS142SLF ..... 2½" Full-sweep Boost 30PSI Gauge

GS342SLF ..... 2½" Full-sweep Boost 30PSI Gauge

### Hot Rod

HR142SLF ..... 2½" Full-sweep Boost 30PSI Gauge

HR342SLF ..... 2½" Full-sweep Boost 30PSI Gauge

### Velocity Black

VS142BBLF ..... 2½" Full-sweep Boost 30PSI Gauge

VS342BBLF ..... 2½" Full-sweep Boost 30PSI Gauge

--With Performance Bezel--

VS342BAPF ..... 2½" Full-sweep Boost 30PSI Gauge, Aluminum

VS342BBPF ..... 2½" Full-sweep Boost 30PSI Gauge, Black

### Velocity White

VS142WBLF ..... 2½" Full-sweep Boost 30PSI Gauge

VS342WBLF ..... 2½" Full-sweep Boost 30PSI Gauge

--With Performance Bezel--

VS342WAPF ... 2½" Full-sweep Boost 30PSI Gauge, Aluminum

VS342WBPF ..... 2½" Full-sweep Boost 30PSI Gauge, Black

### White Hot

WH142SLF ..... 2½" Full-sweep Boost 30PSI Gauge

WH342SLF ..... 2½" Full-sweep Boost 30PSI Gauge

## Boost Gauges, 60 PSI

### AutoCross Gray

AX143GBLF ..... 2½" Full-sweep Boost 60PSI Gauge

AX343GBLF ..... 2½" Full-sweep Boost 60PSI Gauge

--With Performance Bezel--

AX343GAPF ... 2½" Full-sweep Boost 60PSI Gauge, Aluminum

AX343GBPF ... 2½" Full-sweep Boost 60PSI Gauge, Black

### AutoCross Yellow

AX143YBLF ..... 2½" Full-sweep Boost 60PSI Gauge

AX343YBLF ..... 2½" Full-sweep Boost 60PSI Gauge

--With Performance Bezel--

AX343YAPF ... 2½" Full-sweep Boost 60PSI Gauge, Aluminum

AX343YBPF ... 2½" Full-sweep Boost 60PSI Gauge, Black

### G-Stock

GS143SLF ..... 2½" Full-sweep Boost 60PSI Gauge

GS343SLF ..... 2½" Full-sweep Boost 60PSI Gauge

### Hot Rod

HR143SLF ..... 2½" Full-sweep Boost 60PSI Gauge

HR343SLF ..... 2½" Full-sweep Boost 60PSI Gauge

### Velocity Black

VS143BBLF ..... 2½" Full-sweep Boost 60PSI Gauge

VS343BBLF ..... 2½" Full-sweep Boost 60PSI Gauge

--With Performance Bezel--

VS343BAPF ... 2½" Full-sweep Boost 60PSI Gauge, Aluminum

VS343BBPF ..... 2½" Full-sweep Boost 60PSI Gauge, Black

### Velocity White

VS143WBLF ..... 2½" Full-sweep Boost 60PSI Gauge

VS343WBLF ..... 2½" Full-sweep Boost 60PSI Gauge

--With Performance Bezel--

VS343WAPF ... 2½" Full-sweep Boost 60PSI Gauge, Aluminum

VS343WBPF ..... 2½" Full-sweep Boost 60PSI Gauge, Black

### White Hot

WH143SLF ..... 2½" Full-sweep Boost 60PSI Gauge

WH343SLF ..... 2½" Full-sweep Boost 60PSI Gauge

## Fuel Pressure Gauges, 15 PSI

### AutoCross Gray

AX145GBLF ... 2½" Full-sweep Fuel Pressure 15PSI Gauge

AX345GBLF ... 2½" Full-sweep Fuel Pressure 15PSI Gauge

--With Performance Bezel--

AX345GAPF ... 2½" Full-sweep Fuel Press 15PSI Gauge, Aluminum

AX345GBPF ... 2½" Full-sweep Fuel Press 15PSI Gauge, Black

### AutoCross Yellow

AX145YBLF ..... 2½" Full-sweep Fuel Pressure 15PSI Gauge

AX345YBLF ..... 2½" Full-sweep Fuel Pressure 15PSI Gauge

--With Performance Bezel--

AX345YAPF ..... 2½" Full-sweep Fuel Press 15PSI Gauge, Aluminum

AX345YBPF ..... 2½" Full-sweep Fuel Press 15PSI Gauge, Black

### G-Stock

GS145SLF ..... 2½" Full-sweep Fuel Pressure 15PSI Gauge

GS345SLF ..... 2½" Full-sweep Fuel Pressure 15PSI Gauge

### Hot Rod

HR145SLF ..... 2½" Full-sweep Fuel Pressure 15PSI Gauge

HR345SLF ..... 2½" Full-sweep Fuel Pressure 15PSI Gauge

### Velocity Black

VS145BBLF ..... 2½" Full-sweep Fuel Pressure 15PSI Gauge

VS345BBLF ..... 2½" Full-sweep Fuel Pressure 15PSI Gauge

--With Performance Bezel--

VS345BAPF ..... 2½" Full-sweep Fuel Press 15PSI Gauge, Aluminum

VS345BBPF ..... 2½" Full-sweep Fuel Press 15PSI Gauge, Black

### Velocity White

VS145WBLF ..... 2½" Full-sweep Fuel Pressure 15PSI Gauge

VS345WBLF ..... 2½" Full-sweep Fuel Pressure 15PSI Gauge

--With Performance Bezel--

VS345WAPF ..... 2½" Full-sweep Fuel Press 15PSI Gauge, Aluminum

VS345WBPF ..... 2½" Full-sweep Fuel Press 15PSI Gauge, Black

### White Hot

WH145SLF ..... 2½" Full-sweep Fuel Pressure 15PSI Gauge

WH345SLF ..... 2½" Full-sweep Fuel Pressure 15PSI Gauge

## Fuel Pressure Gauges, 100 PSI

### AutoCross Gray

AX146GBLF ..... 2½" Full-sweep Fuel Pressure 100PSI Gauge

AX346GBLF ..... 2½" Full-sweep Fuel Pressure 100PSI Gauge

--With Performance Bezel--

AX346GAPF ..... 2½" Full-sweep Fuel Press 100PSI Gauge, Aluminum

AX346GBPF ... 2½" Full-sweep Fuel Press 100PSI Gauge, Black

### AutoCross Yellow

AX146YBLF ..... 2½" Full-sweep Fuel Pressure 100PSI Gauge

AX346YBLF ..... 2½" Full-sweep Fuel Pressure 100PSI Gauge

# Part Number Index

--With Performance Bezel--

AX346YAPF .....2½" Full-sweep Fuel Press 100Psi Gauge, Aluminum  
AX346YBPF..... 2½" Full-sweep Fuel Press 100Psi Gauge, Black  
**G-Stock**  
GS146SLF ..... 2½" Full-sweep Fuel Pressure 100Psi Gauge  
GS346SLF ..... 2½" Full-sweep Fuel Pressure 100Psi Gauge  
**Hot Rod**  
HR146SLF ..... 2½" Full-sweep Fuel Pressure 100Psi Gauge  
HR346SLF..... 2½" Full-sweep Fuel Pressure 100Psi Gauge

**Velocity Black**

VS146BBLF ..... 2½" Full-sweep Fuel Pressure 100Psi Gauge  
VS346BBLF ..... 2½" Full-sweep Fuel Pressure 100Psi Gauge

--With Performance Bezel--

VS346BAPF .....2½" Full-sweep Fuel Press 100Psi Gauge, Aluminum  
VS346BBPF ..... 2½" Full-sweep Fuel Press 100Psi Gauge, Black  
**Velocity White**  
VS146WBLF ..... 2½" Full-sweep Fuel Pressure 100Psi Gauge  
VS346WBLF ..... 2½" Full-sweep Fuel Pressure 100Psi Gauge

--With Performance Bezel--

VS346WAPF .....2½" Full-sweep Fuel Press 100Psi Gauge, Aluminum  
VS346WBPF ..... 2½" Full-sweep Fuel Press 100Psi Gauge, Black  
**White Hot**  
WH146SLF ..... 2½" Full-sweep Fuel Pressure 100Psi Gauge  
WH346SLF ..... 2½" Full-sweep Fuel Pressure 100Psi Gauge

## Brake Pressure Gauges

**AutoCross Gray**

AX167GBLF ..... 2½" Full-sweep Brake Pressure Gauge  
AX367GBLF ..... 2½" Full-sweep Brake Pressure Gauge

--With Performance Bezel--

AX367GAPF .....2½" Full-sweep Brake Pressure Gauge, Aluminum  
AX367GBPF ..... 2½" Full-sweep Brake Pressure Gauge, Black

**AutoCross Yellow**

AX167YBLF ..... 2½" Full-sweep Brake Pressure Gauge  
AX367YBLF ..... 2½" Full-sweep Brake Pressure Gauge

--With Performance Bezel--

AX367YAPF ..... 2½" Full-sweep Brake Pressure Gauge, Aluminum  
AX367YBPF ..... 2½" Full-sweep Brake Pressure Gauge, Black

**G-Stock**

GS167SLF ..... 2½" Full-sweep Brake Pressure Gauge  
GS367SLF ..... 2½" Full-sweep Brake Pressure Gauge

**Hot Rod**

HR167SLF ..... 2½" Full-sweep Brake Pressure Gauge  
HR367SLF ..... 2½" Full-sweep Brake Pressure Gauge

**Velocity Black**

VS167BBLF ..... 2½" Full-sweep Brake Pressure Gauge  
VS367BBLF ..... 2½" Full-sweep Brake Pressure Gauge

--With Performance Bezel--

VS367BAPF .....2½" Full-sweep Brake Pressure Gauge, Aluminum  
VS367BBPF ..... 2½" Full-sweep Brake Pressure Gauge, Black

**Velocity White**

VS167WBLF ..... 2½" Full-sweep Brake Pressure Gauge  
VS367WBLF ..... 2½" Full-sweep Brake Pressure Gauge

--With Performance Bezel--

VS367WAPF .....2½" Full-sweep Brake Pressure Gauge, Aluminum  
VS367WBPF ..... 2½" Full-sweep Brake Pressure Gauge, Black

**White Hot**

WH167SLF ..... 2½" Full-sweep Brake Pressure Gauge  
WH367SLF ..... 2½" Full-sweep Brake Pressure Gauge

## Oil Pressure Gauges

Sender purchased separately on 2½" short-sweep gauges

**AutoCross Gray**

AX81GBLF ..... 2½" Short-sweep Oil Pressure Gauge  
AX181GBLF ..... 2½" Full-sweep Oil Pressure Gauge

AX281GBLF ..... 2½" Short-sweep Oil Pressure Gauge  
AX381GBLF ..... 2½" Full-sweep Oil Pressure Gauge

--With Performance Bezel--

AX281GAPF ..... 2½" Short-sweep Oil Pressure Gauge, Aluminum  
AX281GBPF ..... 2½" Short-sweep Oil Pressure Gauge, Black  
AX381GAPF ..... 2½" Full-sweep Oil Pressure Gauge, Aluminum

AX381GBPF ..... 2½" Full-sweep Oil Pressure Gauge, Black

**AutoCross Yellow**

AX81YBLF ..... 2½" Short-sweep Oil Pressure Gauge  
AX181YBLF ..... 2½" Full-sweep Oil Pressure Gauge

AX281YBLF ..... 2½" Short-sweep Oil Pressure Gauge  
AX381YBLF ..... 2½" Full-sweep Oil Pressure Gauge

--With Performance Bezel--

AX281YAPF ..... 2½" Short-sweep Oil Pressure Gauge, Aluminum  
AX281YBPF ..... 2½" Short-sweep Oil Pressure Gauge, Black

AX381YAPF ..... 2½" Full-sweep Oil Pressure Gauge, Aluminum  
AX381YBPF ..... 2½" Full-sweep Oil Pressure Gauge, Black

**G-Stock**

GS81SLF ..... 2½" Short-sweep Oil Pressure Gauge  
GS181SLF ..... 2½" Full-sweep Oil Pressure Gauge

GS281SLF ..... 2½" Short-sweep Oil Pressure Gauge  
GS381SLF ..... 2½" Full-sweep Oil Pressure Gauge

**Hot Rod**

HR81SLF ..... 2½" Short-sweep Oil Pressure Gauge  
HR181SLF ..... 2½" Full-sweep Oil Pressure Gauge

HR281SLF ..... 2½" Short-sweep Oil Pressure Gauge  
HR381SLF ..... 2½" Full-sweep Oil Pressure Gauge

**Velocity Black**

VS81BBLF ..... 2½" Short-sweep Oil Pressure Gauge  
VS181BBLF ..... 2½" Full-sweep Oil Pressure Gauge

VS281BBLF ..... 2½" Short-sweep Oil Pressure Gauge  
VS381BBLF ..... 2½" Full-sweep Oil Pressure Gauge

--With Performance Bezel--

VS281BAPF ..... 2½" Short-sweep Oil Pressure Gauge, Aluminum  
VS281BBPF ..... 2½" Short-sweep Oil Pressure Gauge, Black

VS381BAPF ..... 2½" Full-sweep Oil Pressure Gauge, Aluminum  
VS381BBPF ..... 2½" Full-sweep Oil Pressure Gauge, Black

**Velocity White**

VS81WBLF ..... 2½" Short-sweep Oil Pressure Gauge  
VS181WBLF ..... 2½" Full-sweep Oil Pressure Gauge

VS281WBLF ..... 2½" Short-sweep Oil Pressure Gauge  
VS381WBLF ..... 2½" Full-sweep Oil Pressure Gauge

--With Performance Bezel--

VS281WAPF ..... 2½" Short-sweep Oil Pressure Gauge, Aluminum  
VS281WBPF ..... 2½" Short-sweep Oil Pressure Gauge, Black

VS381WAPF ..... 2½" Full-sweep Oil Pressure Gauge, Aluminum  
VS381WBPF ..... 2½" Full-sweep Oil Pressure Gauge, Black



## White Hot

WH181SLF ..... 2 1/8" Short-sweep Oil Pressure Gauge  
WH181SLF ..... 2 1/8" Full-sweep Oil Pressure Gauge  
WH281SLF ..... 2 5/8" Short-sweep Oil Pressure Gauge  
WH381SLF ..... 2 5/8" Full-sweep Oil Pressure Gauge

## Tachometers

### AutoCross Gray

AX183GBLF ..... 2 1/8" Full-sweep Tachometer  
AX383GBLF ..... 2 5/8" Full-sweep Tachometer  
--With Performance Bezel--  
AX383GAPF ..... 2 5/8" Full-sweep Tachometer, Aluminum  
AX383GBPF ..... 2 5/8" Full-sweep Tachometer, Black

### AutoCross Yellow

AX183YBLF ..... 2 1/8" Full-sweep Tachometer  
AX383YBLF ..... 2 5/8" Full-sweep Tachometer  
--With Performance Bezel--  
AX383YAPF ..... 2 5/8" Full-sweep Tachometer, Aluminum  
AX383YBPF ..... 2 5/8" Full-sweep Tachometer, Black

### G-Stock

GS183SLF ..... 2 1/8" Full-sweep Tachometer  
GS383SLF ..... 2 5/8" Full-sweep Tachometer  
**Hot Rod**

HR183SLF ..... 2 1/8" Full-sweep Tachometer  
HR383SLF ..... 2 5/8" Full-sweep Tachometer

### Velocity Black

VS183BBLF ..... 2 1/8" Full-sweep Tachometer  
VS383BBLF ..... 2 5/8" Full-sweep Tachometer  
--With Performance Bezel--

VS383BAPF ..... 2 5/8" Full-sweep Tachometer, Aluminum  
VS383BBPF ..... 2 5/8" Full-sweep Tachometer, Black

### Velocity White

VS183WBLF ..... 2 1/8" Full-sweep Tachometer  
VS383WBLF ..... 2 5/8" Full-sweep Tachometer  
--With Performance Bezel--

VS383WAPF ..... 2 5/8" Full-sweep Tachometer, Aluminum  
VS383WBPF ..... 2 5/8" Full-sweep Tachometer, Black

### White Hot

WH183SLF ..... 2 1/8" Full-sweep Tachometer  
WH383SLF ..... 2 5/8" Full-sweep Tachometer

## Air/Fuel Ratio Gauges

### AutoCross Gray

AX194GBLF .... 2 1/8" Full-sweep Air/Fuel Ratio Gauge  
AX394GBLF .... 2 5/8" Full-sweep Air/Fuel Ratio Gauge

--With Performance Bezel--

AX394GAPF .... 2 5/8" Full-sweep Air/Fuel Ratio Gauge, Aluminum

AX394GBPF .... 2 5/8" Full-sweep Air/Fuel Ratio Gauge, Black

### AutoCross Yellow

AX194YBLF ..... 2 1/8" Full-sweep Air/Fuel Ratio Gauge  
AX394YBLF ..... 2 5/8" Full-sweep Air/Fuel Ratio Gauge

--With Performance Bezel--

AX394YAPF ..... 2 5/8" Full-sweep Air/Fuel Ratio Gauge, Aluminum

AX394YBPF ..... 2 5/8" Full-sweep Air/Fuel Ratio Gauge, Black

### G-Stock

GS194SLF ..... 2 1/8" Full-sweep Air/Fuel Ratio Gauge  
GS394SLF ..... 2 5/8" Full-sweep Air/Fuel Ratio Gauge

### Hot Rod

HR194SLF ..... 2 1/8" Full-sweep Air/Fuel Ratio Gauge  
HR394SLF ..... 2 5/8" Full-sweep Air/Fuel Ratio Gauge

### Velocity Black

VS194BBLF ..... 2 1/8" Full-sweep Air/Fuel Ratio Gauge  
VS394BBLF ..... 2 5/8" Full-sweep Air/Fuel Ratio Gauge

--With Performance Bezel--

VS394BAPF ..... 2 5/8" Full-sweep Air/Fuel Ratio Gauge, Aluminum

VS394BBPF ..... 2 5/8" Full-sweep Air/Fuel Ratio Gauge, Black

### Velocity White

VS194WBLF ..... 2 1/8" Full-sweep Air/Fuel Ratio Gauge  
VS394WBLF ..... 2 5/8" Full-sweep Air/Fuel Ratio Gauge

--With Performance Bezel--

VS394WAPF ..... 2 5/8" Full-sweep Air/Fuel Ratio Gauge, Aluminum  
VS394WBPF ..... 2 5/8" Full-sweep Air/Fuel Ratio Gauge, Black

### White Hot

WH194SLF ..... 2 1/8" Full-sweep Air/Fuel Ratio Gauge  
WH394SLF ..... 2 5/8" Full-sweep Air/Fuel Ratio Gauge

## Cylinder Head Temperature Gauges

### AutoCross Gray

AX197GBLF ..... 2 1/8" Full-sweep Cylinder Head Temp. Gauge  
AX397GBLF ..... 2 5/8" Full-sweep Cylinder Head Temp. Gauge

--With Performance Bezel--

AX397GAPF ..... 2 5/8" Full-sweep Cylinder Head Temp., Aluminum  
AX397GBPF ..... 2 5/8" Full-sweep Cylinder Head Temp., Black

### AutoCross Yellow

AX197YBLF ..... 2 1/8" Full-sweep Cylinder Head Temp. Gauge  
AX397YBLF ..... 2 5/8" Full-sweep Cylinder Head Temp. Gauge

--With Performance Bezel--

AX397YAPF ..... 2 5/8" Full-sweep CHT Gauge, Aluminum  
AX397YBPF ..... 2 5/8" Full-sweep CHT Gauge, Black

### G-Stock

GS197SLF ..... 2 1/8" Full-sweep Cylinder Head Temp. Gauge  
GS397SLF ..... 2 5/8" Full-sweep Cylinder Head Temp. Gauge

### Hot Rod

HR197SLF ..... 2 1/8" Full-sweep Cylinder Head Temp. Gauge  
HR397SLF ..... 2 5/8" Full-sweep Cylinder Head Temp. Gauge

### Velocity Black

VS197BBLF ..... 2 1/8" Full-sweep Cylinder Head Temp. Gauge  
VS397BBLF ..... 2 5/8" Full-sweep Cylinder Head Temp. Gauge

--With Performance Bezel--

VS397BAPF ..... 2 5/8" Full-sweep Cylinder Head Temp., Aluminum  
VS397BBPF ..... 2 5/8" Full-sweep Cylinder Head Temp., Black

### Velocity White

VS197WBLF ..... 2 1/8" Full-sweep Cylinder Head Temp. Gauge  
VS397WBLF ..... 2 5/8" Full-sweep Cylinder Head Temp. Gauge

--With Performance Bezel--

VS397WAPF ..... 2 5/8" Full-sweep CHT Gauge, Aluminum  
VS397WBPF ..... 2 5/8" Full-sweep CHT Gauge, Black

### White Hot

WH197SLF ..... 2 1/8" Full-sweep Cylinder Head Temp. Gauge  
WH397SLF ..... 2 5/8" Full-sweep Cylinder Head Temp. Gauge

## Exhaust Gas Temperature Gauges

### AutoCross Gray

AX198GBLF ..... 2 1/8" Full-sweep Exhaust Gas Temp. Gauge  
AX398GBLF ..... 2 5/8" Full-sweep Exhaust Gas Temp. Gauge

# Part Number Index

--With Performance Bezel--

AX398GAPF.....2½" Full-sweep Exhaust Gas Temp., Aluminum

AX398GBPF.....2½" Full-sweep Exhaust Gas Temp., Black

**AutoCross Yellow**

AX198YBLF ..... 2½" Full-sweep Exhaust Gas Temp. Gauge

AX398YBLF ..... 2½" Full-sweep Exhaust Gas Temp. Gauge

--With Performance Bezel--

AX398YAPF ..... 2½" Full-sweep EGT Gauge, Aluminum

AX398YBPF ..... 2½" Full-sweep EGT Gauge, Black

**G-Stock**

GS198SLF..... 2½" Full-sweep Exhaust Gas Temp. Gauge

GS398SLF ..... 2½" Full-sweep Exhaust Gas Temp. Gauge

**Hot Rod**

HR198SLF ..... 2½" Full-sweep Exhaust Gas Temp. Gauge

HR398SLF ..... 2½" Full-sweep Exhaust Gas Temp. Gauge

**Velocity Black**

VS198BBLF ..... 2½" Full-sweep Exhaust Gas Temp. Gauge

VS398BBLF ..... 2½" Full-sweep Exhaust Gas Temp. Gauge

--With Performance Bezel--

VS398BAPF ..... 2½" Full-sweep Exhaust Gas Temp., Aluminum

VS398BBPF ..... 2½" Full-sweep Exhaust Gas Temp., Black

**Velocity White**

VS198WBLF ..... 2½" Full-sweep Exhaust Gas Temp. Gauge

VS398WBLF ..... 2½" Full-sweep Exhaust Gas Temp. Gauge

--With Performance Bezel--

VS398WAPF ..... 2½" Full-sweep EGT Gauge, Aluminum

VS398WBPF ..... 2½" Full-sweep EGT Gauge, Black

**White Hot**

WH198SLF ..... 2½" Full-sweep Exhaust Gas Temp. Gauge

WH398SLF ..... 2½" Full-sweep Exhaust Gas Temp. Gauge

## Outside Air Temperature Gauges

**AutoCross Gray**

AX199GBLF ..... 2½" Full-sweep Outside Air Temp. Gauge

AX399GBLF ..... 2½" Full-sweep Outside Air Temp. Gauge

--With Performance Bezel--

AX399GAPF.....2½" Full-sweep Outside Air Temp., Aluminum

AX399GBPF..... 2½" Full-sweep Outside Air Temp., Black

**AutoCross Yellow**

AX199YBLF ..... 2½" Full-sweep Outside Air Temp. Gauge

AX399YBLF ..... 2½" Full-sweep Outside Air Temp. Gauge

--With Performance Bezel--

AX399YAPF ..... 2½" Full-sweep Outside Temp. Gauge, Aluminum

AX399YBPF ..... 2½" Full-sweep Outside Temp. Gauge, Black

**G-Stock**

GS199SLF ..... 2½" Full-sweep Outside Air Temp. Gauge

GS399SLF ..... 2½" Full-sweep Outside Air Temp. Gauge

**Hot Rod**

HR199SLF ..... 2½" Full-sweep Outside Air Temp. Gauge

HR399SLF ..... 2½" Full-sweep Outside Air Temp. Gauge

**Velocity Black**

VS199BBLF ..... 2½" Full-sweep Outside Air Temp. Gauge

VS399BBLF ..... 2½" Full-sweep Outside Air Temp. Gauge

--With Performance Bezel--

VS399BAPF ..... 2½" Full-sweep Outside Air Temp., Aluminum

VS399BBPF ..... 2½" Full-sweep Outside Air Temp., Black

**Velocity White**

VS199WBLF ..... 2½" Full-sweep Outside Air Temp. Gauge

VS399WBLF ..... 2½" Full-sweep Outside Air Temp. Gauge

--With Performance Bezel--

VS399WAPF ..... 2½" Full-sweep Outside Air Temp., Aluminum

VS399WBPF ..... 2½" Full-sweep Outside Air Temp., Black

**White Hot**

WH199SLF ..... 2½" Full-sweep Outside Air Temp. Gauge

WH399SLF ..... 2½" Full-sweep Outside Air Temp. Gauge

## Matching Speedometers and Tachometers

**AutoCross Gray**

AX50GBLF ..... 4½" Speedtachular, Speedo/Tach combination

AX56GBLF ..... 4½" Speedometer, 200 MPH

AX57GBLF ..... 3½" Speedometer, 200 MPH

AX71GBLF ..... 4½" Tachometer, 10,000 RPM

AX80GBLF ..... 3½" Tachometer, 10,000 RPM

**AutoCross Yellow**

AX50YBLF ..... 4½" Speedtachular, Speedo/Tach combination

AX56YBLF ..... 4½" Speedometer, 200 MPH

AX57YBLF ..... 3½" Speedometer, 200 MPH

AX71YBLF ..... 4½" Tachometer, 10,000 RPM

AX80YBLF ..... 3½" Tachometer, 10,000 RPM

**G-Stock**

GS20SLF ..... 3½" Ultimate, Speedo/Tach combination

GS50SLF ..... 4½" Speedtachular, Speedo/Tach combination

GS55SLF ..... 3½" Speedometer, 140MPH

GS56SLF ..... 4½" Speedometer, 140MPH

GS71SLF ..... 4½" Tachometer, 8,000RPM

GS80SLF ..... 3½" Tachometer, 8,000RPM

**Hot Rod**

HR10SLF ..... 3½" Tachometer, 10,000 RPM

HR20SLF ..... 3½" Ultimate, Speedo/Tach combination

HR50SLF ..... 4½" Speedtachular, Speedo/Tach combination

HR55SLF ..... 3½" Speedometer, 140 MPH

HR56SLF ..... 4½" Speedometer, 140 MPH

HR57SLF ..... 3½" Speedometer, 200 MPH

HR60SLF ..... 3½" Tachometer, 6,000 RPM

HR71SLF ..... 4½" Tachometer, 8,000 RPM

HR80SLF ..... 3½" Tachometer, 8,000 RPM

**Velocity Black**

VS10BBLF ..... 3½" Tachometer, 10,000 RPM

VS20BBLF ..... 3½" Ultimate, Speedo/Tach combination

VS50BBLF ..... 4½" Speedtachular, Speedo/Tach combination

VS55BBLF ..... 3½" Speedometer, 160 MPH

VS56BBLF ..... 4½" Speedometer, 160 MPH

VS57BBLF ..... 3½" Speedometer, 200 MPH

VS71BBLF ..... 4½" Tachometer, 10,000 RPM

**Velocity White**

VS10WBLF ..... 3½" Tachometer, 10,000 RPM

VS20WBLF ..... 3½" Ultimate, Speedo/Tach combination

VS50WBLF ..... 4½" Speedtachular, Speedo/Tach combination

VS55WBLF ..... 3½" Speedometer, 160 MPH

VS56WBLF ..... 4½" Speedometer, 160 MPH

VS57WBLF ..... 3½" Speedometer, 200 MPH

VS71WBLF ..... 4½" Tachometer, 10,000 RPM

**White Hot**

WH10SLF ..... 3½" Tachometer, 10,000 RPM

WH20SLF ..... 3½" Ultimate, Speedo/Tach combination

WH50SLF ..... 4½" Speedtachular, Speedo/Tach combination

WH55SLF ..... 3½" Speedometer, 140 MPH

WH56SLF ..... 4½" Speedometer, 140 MPH

WH57SLF ..... 3<sup>3</sup>/<sub>8</sub>" Speedometer, 200 MPH  
 WH60SLF ..... 3<sup>3</sup>/<sub>8</sub>" Tachometer, 6,000 RPM  
 WH71SLF ..... 4<sup>5</sup>/<sub>8</sub>" Tachometer, 8,000 RPM  
 WH80SLF ..... 3<sup>3</sup>/<sub>8</sub>" Tachometer, 8,000 RPM

### Accessories

MT02B ..... 2<sup>1</sup>/<sub>8</sub>" Tachometer Mounting Cup, Matte Black  
 MT02C ..... 2<sup>1</sup>/<sub>8</sub>" Tachometer Mounting Cup, Chrome  
 MT51 ..... 3<sup>3</sup>/<sub>8</sub>" Tachometer Mounting Cup, Chrome  
 MT52 ..... 3<sup>3</sup>/<sub>8</sub>" Tachometer Mounting Cup, Matte Black  
 MT55 ..... Two-hole Under Dash Panel, holds 2<sup>1</sup>/<sub>8</sub>" gauges  
 MT56 ..... Three-hole Under Dash Panel, holds 2<sup>1</sup>/<sub>8</sub>" gauges  
 MT58 ..... Two-hole Under Dash Panel, holds 2<sup>5</sup>/<sub>8</sub>" gauges  
 MT59 ..... Three-hole Under Dash Panel, holds 2<sup>5</sup>/<sub>8</sub>" gauges

### Three, Five, and Six Gauge Sets

--Three Gauge Sets: Temp, Volt, Oil Pressure--

#### AutoCross Gray

AX33GSLF ..... 2<sup>1</sup>/<sub>8</sub>" Short-sweep, Temp, Volt, Oil Pressure  
 AX133GSLF ..... 2<sup>1</sup>/<sub>8</sub>" Full-sweep, Temp, Volt, Oil Pressure  
 AX233GSLF ..... 2<sup>5</sup>/<sub>8</sub>" Short-sweep, Temp, Volt, Oil Pressure  
 AX333GSLF ..... 2<sup>5</sup>/<sub>8</sub>" Full-sweep, Temp, Volt, Oil Pressure

#### AutoCross Yellow

AX33YSLF ..... 2<sup>1</sup>/<sub>8</sub>" Short-sweep, Temp, Volt, Oil Pressure  
 AX133YSLF ..... 2<sup>1</sup>/<sub>8</sub>" Full-sweep, Temp, Volt, Oil Pressure  
 AX233YSLF ..... 2<sup>5</sup>/<sub>8</sub>" Short-sweep, Temp, Volt, Oil Pressure  
 AX333YSLF ..... 2<sup>5</sup>/<sub>8</sub>" Full-sweep, Temp, Volt, Oil Pressure

#### G-Stock

GS33SLF ..... 2<sup>1</sup>/<sub>8</sub>" Short-sweep, Temp, Volt, Oil Pressure  
 GS133SLF ..... 2<sup>1</sup>/<sub>8</sub>" Full-sweep, Temp, Volt, Oil Pressure  
 GS233BLF ..... 2<sup>5</sup>/<sub>8</sub>" Short-sweep, Temp, Volt, Oil Pressure  
 GS333BLF ..... 2<sup>5</sup>/<sub>8</sub>" Full-sweep, Temp, Volt, Oil Pressure

#### Hot Rod

HR33SLF ..... 2<sup>1</sup>/<sub>8</sub>" Short-sweep, Temp, Volt, Oil Pressure  
 HR133SLF ..... 2<sup>1</sup>/<sub>8</sub>" Full-sweep, Temp, Volt, Oil Pressure  
 HR233BLF ..... 2<sup>5</sup>/<sub>8</sub>" Short-sweep, Temp, Volt, Oil Pressure  
 HR333BLF ..... 2<sup>5</sup>/<sub>8</sub>" Full-sweep, Temp, Volt, Oil Pressure

#### Velocity Black

VS33BSLF ..... 2<sup>1</sup>/<sub>8</sub>" Short-sweep, Temp, Volt, Oil Pressure

VS133BSLF ..... 2<sup>1</sup>/<sub>8</sub>" Full-sweep, Temp, Volt, Oil Pressure  
 VS233BSLF ..... 2<sup>5</sup>/<sub>8</sub>" Short-sweep, Temp, Volt, Oil Pressure  
 VS333BSLF ..... 2<sup>5</sup>/<sub>8</sub>" Full-sweep, Temp, Volt, Oil Pressure

#### Velocity White

VS33WSLF ..... 2<sup>1</sup>/<sub>8</sub>" Short-sweep, Temp, Volt, Oil Pressure  
 VS133WSLF ..... 2<sup>1</sup>/<sub>8</sub>" Full-sweep, Temp, Volt, Oil Pressure  
 VS233WBLF ..... 2<sup>5</sup>/<sub>8</sub>" Short-sweep, Temp, Volt, Oil Pressure  
 VS333WBLF ..... 2<sup>5</sup>/<sub>8</sub>" Full-sweep, Temp, Volt, Oil Pressure

#### White Hot

WH33SLF ..... 2<sup>1</sup>/<sub>8</sub>" Short-sweep, Temp, Volt, Oil Pressure  
 WH133SLF ..... 2<sup>1</sup>/<sub>8</sub>" Full-sweep, Temp, Volt, Oil Pressure  
 WH233BLF ..... 2<sup>5</sup>/<sub>8</sub>" Short-sweep, Temp, Volt, Oil Pressure  
 WH333BLF ..... 2<sup>5</sup>/<sub>8</sub>" Full-sweep, Temp, Volt, Oil Pressure

--Five Gauge Sets: Speedometer, Fuel, Oil, Temp, Volt--

#### AutoCross Gray

AX00GBLF ..... 3<sup>3</sup>/<sub>8</sub>" Speedo, 2<sup>1</sup>/<sub>8</sub>" Short-sweep smalls  
 AX100GBLF ..... 3<sup>3</sup>/<sub>8</sub>" Speedo, 2<sup>1</sup>/<sub>8</sub>" Full-sweep smalls  
 AX200GBLF ..... 3<sup>3</sup>/<sub>8</sub>" Speedo, 2<sup>5</sup>/<sub>8</sub>" Short-sweep smalls  
 AX300GBLF ..... 3<sup>3</sup>/<sub>8</sub>" Speedo, 2<sup>5</sup>/<sub>8</sub>" Full-sweep smalls  
 AX45GBLF ..... 4<sup>5</sup>/<sub>8</sub>" Speedo, 2<sup>1</sup>/<sub>8</sub>" Short-sweep smalls  
 AX154GBLF ..... 4<sup>5</sup>/<sub>8</sub>" Speedo, 2<sup>1</sup>/<sub>8</sub>" Full-sweep smalls  
 AX254GBLF ..... 4<sup>5</sup>/<sub>8</sub>" Speedo, 2<sup>5</sup>/<sub>8</sub>" Short-sweep smalls  
 AX354GBLF ..... 4<sup>5</sup>/<sub>8</sub>" Speedo, 2<sup>5</sup>/<sub>8</sub>" Full-sweep smalls

#### AutoCross Yellow

AX00YBLF ..... 3<sup>3</sup>/<sub>8</sub>" Speedo, 2<sup>1</sup>/<sub>8</sub>" Short-sweep smalls  
 AX100YBLF ..... 3<sup>3</sup>/<sub>8</sub>" Speedo, 2<sup>1</sup>/<sub>8</sub>" Full-sweep smalls  
 AX200YBLF ..... 3<sup>3</sup>/<sub>8</sub>" Speedo, 2<sup>5</sup>/<sub>8</sub>" Short-sweep smalls  
 AX300YBLF ..... 3<sup>3</sup>/<sub>8</sub>" Speedo, 2<sup>5</sup>/<sub>8</sub>" Full-sweep smalls  
 AX45YBLF ..... 4<sup>5</sup>/<sub>8</sub>" Speedo, 2<sup>1</sup>/<sub>8</sub>" Short-sweep smalls  
 AX154YBLF ..... 4<sup>5</sup>/<sub>8</sub>" Speedo, 2<sup>1</sup>/<sub>8</sub>" Full-sweep smalls  
 AX254YBLF ..... 4<sup>5</sup>/<sub>8</sub>" Speedo, 2<sup>5</sup>/<sub>8</sub>" Short-sweep smalls  
 AX354YBLF ..... 4<sup>5</sup>/<sub>8</sub>" Speedo, 2<sup>5</sup>/<sub>8</sub>" Full-sweep smalls

#### G-Stock

GS00SLF ..... 3<sup>3</sup>/<sub>8</sub>" Speedo, 2<sup>1</sup>/<sub>8</sub>" Short-sweep smalls  
 GS100SLF ..... 3<sup>3</sup>/<sub>8</sub>" Speedo, 2<sup>1</sup>/<sub>8</sub>" Full-sweep smalls  
 GS200SLF ..... 3<sup>3</sup>/<sub>8</sub>" Speedo, 2<sup>5</sup>/<sub>8</sub>" Short-sweep smalls  
 GS300SLF ..... 3<sup>3</sup>/<sub>8</sub>" Speedo, 2<sup>5</sup>/<sub>8</sub>" Full-sweep smalls  
 GS45SLF ..... 4<sup>5</sup>/<sub>8</sub>" Speedo, 2<sup>1</sup>/<sub>8</sub>" Short-sweep smalls  
 GS154SLF ..... 4<sup>5</sup>/<sub>8</sub>" Speedo, 2<sup>1</sup>/<sub>8</sub>" Full-sweep smalls

GS254SLF ..... 4<sup>5</sup>/<sub>8</sub>" Speedo, 2<sup>5</sup>/<sub>8</sub>" Short-sweep smalls  
 GS354SLF ..... 4<sup>5</sup>/<sub>8</sub>" Speedo, 2<sup>5</sup>/<sub>8</sub>" Full-sweep smalls

#### Hot Rod

HR00SLF ..... 3<sup>3</sup>/<sub>8</sub>" Speedo, 2<sup>1</sup>/<sub>8</sub>" Short-sweep smalls  
 HR100SLF ..... 3<sup>3</sup>/<sub>8</sub>" Speedo, 2<sup>1</sup>/<sub>8</sub>" Full-sweep smalls  
 HR200SLF ..... 3<sup>3</sup>/<sub>8</sub>" Speedo, 2<sup>5</sup>/<sub>8</sub>" Short-sweep smalls  
 HR300SLF ..... 3<sup>3</sup>/<sub>8</sub>" Speedo, 2<sup>5</sup>/<sub>8</sub>" Full-sweep smalls  
 HR45SLF ..... 4<sup>5</sup>/<sub>8</sub>" Speedo, 2<sup>1</sup>/<sub>8</sub>" Short-sweep smalls  
 HR154SLF ..... 4<sup>5</sup>/<sub>8</sub>" Speedo, 2<sup>1</sup>/<sub>8</sub>" Full-sweep smalls  
 HR254SLF ..... 4<sup>5</sup>/<sub>8</sub>" Speedo, 2<sup>5</sup>/<sub>8</sub>" Short-sweep smalls  
 HR354SLF ..... 4<sup>5</sup>/<sub>8</sub>" Speedo, 2<sup>5</sup>/<sub>8</sub>" Full-sweep smalls

#### Velocity Black

VS00BBLF ..... 3<sup>3</sup>/<sub>8</sub>" Speedo, 2<sup>1</sup>/<sub>8</sub>" Short-sweep smalls  
 VS100BBLF ..... 3<sup>3</sup>/<sub>8</sub>" Speedo, 2<sup>1</sup>/<sub>8</sub>" Full-sweep smalls  
 VS200BBLF ..... 3<sup>3</sup>/<sub>8</sub>" Speedo, 2<sup>5</sup>/<sub>8</sub>" Short-sweep smalls  
 VS300BBLF ..... 3<sup>3</sup>/<sub>8</sub>" Speedo, 2<sup>5</sup>/<sub>8</sub>" Full-sweep smalls  
 VS45BBLF ..... 4<sup>5</sup>/<sub>8</sub>" Speedo, 2<sup>1</sup>/<sub>8</sub>" Short-sweep smalls  
 VS154BBLF ..... 4<sup>5</sup>/<sub>8</sub>" Speedo, 2<sup>1</sup>/<sub>8</sub>" Full-sweep smalls  
 VS254BBLF ..... 4<sup>5</sup>/<sub>8</sub>" Speedo, 2<sup>5</sup>/<sub>8</sub>" Short-sweep smalls  
 VS354BBLF ..... 4<sup>5</sup>/<sub>8</sub>" Speedo, 2<sup>5</sup>/<sub>8</sub>" Full-sweep smalls

#### Velocity White

VS00WBLF ..... 3<sup>3</sup>/<sub>8</sub>" Speedo, 2<sup>1</sup>/<sub>8</sub>" Short-sweep smalls  
 VS100WBLF ..... 3<sup>3</sup>/<sub>8</sub>" Speedo, 2<sup>1</sup>/<sub>8</sub>" Full-sweep smalls  
 VS200WBLF ..... 3<sup>3</sup>/<sub>8</sub>" Speedo, 2<sup>5</sup>/<sub>8</sub>" Short-sweep smalls  
 VS300WBLF ..... 3<sup>3</sup>/<sub>8</sub>" Speedo, 2<sup>5</sup>/<sub>8</sub>" Full-sweep smalls  
 VS45WBLF ..... 4<sup>5</sup>/<sub>8</sub>" Speedo, 2<sup>1</sup>/<sub>8</sub>" Short-sweep smalls  
 VS154WBLF ..... 4<sup>5</sup>/<sub>8</sub>" Speedo, 2<sup>1</sup>/<sub>8</sub>" Full-sweep smalls  
 VS254WBLF ..... 4<sup>5</sup>/<sub>8</sub>" Speedo, 2<sup>5</sup>/<sub>8</sub>" Short-sweep smalls  
 VS354WBLF ..... 4<sup>5</sup>/<sub>8</sub>" Speedo, 2<sup>5</sup>/<sub>8</sub>" Full-sweep smalls

#### White Hot

WH00SLF ..... 3<sup>3</sup>/<sub>8</sub>" Speedo, 2<sup>1</sup>/<sub>8</sub>" Short-sweep smalls  
 WH100SLF ..... 3<sup>3</sup>/<sub>8</sub>" Speedo, 2<sup>1</sup>/<sub>8</sub>" Full-sweep smalls  
 WH200SLF ..... 3<sup>3</sup>/<sub>8</sub>" Speedo, 2<sup>5</sup>/<sub>8</sub>" Short-sweep smalls  
 WH300SLF ..... 3<sup>3</sup>/<sub>8</sub>" Speedo, 2<sup>5</sup>/<sub>8</sub>" Full-sweep smalls  
 WH45SLF ..... 4<sup>5</sup>/<sub>8</sub>" Speedo, 2<sup>1</sup>/<sub>8</sub>" Short-sweep smalls  
 WH154SLF ..... 4<sup>5</sup>/<sub>8</sub>" Speedo, 2<sup>1</sup>/<sub>8</sub>" Full-sweep smalls  
 WH254SLF ..... 4<sup>5</sup>/<sub>8</sub>" Speedo, 2<sup>5</sup>/<sub>8</sub>" Short-sweep smalls  
 WH354SLF ..... 4<sup>5</sup>/<sub>8</sub>" Speedo, 2<sup>5</sup>/<sub>8</sub>" Full-sweep smalls





## Warranty

Our warranty guarantees the original purchaser that the specified product is free from defects in materials and workmanship for a period of seven years. The manufacturer will repair or replace (at its discretion) any product that fails to conform to this warranty. All warranted products must be used in accordance with the manufacturer's instructions and for the purpose designed and intended. Any modifications, alterations, adverse environmental conditions (fire, flood, etc.) or attempted repair will void the warranty. Warranty is valid only for the original owner of the specified product.

Any product believed to be in need of warranty service must receive an RMA number and must be returned to Classic Instruments for evaluation and testing. Based on the results of these tests and current product availability, the product may be repaired or replaced at the sole discretion of Classic Instruments. Owner is responsible for all charges relating to removal / installation of warranted products and all shipping and handling charges relating to returned warranted products. Upon purchase of the lifetime warranty the buyer agrees to the conditions stated above. For questions regarding warranty or product please call us.

[classicinstruments.com](http://classicinstruments.com) | 800.575.0461

Also ask about our lifetime warranty.

## Community & Industry Involvement

Classic Instruments is a proud sponsor of community events and local charitable organizations to include:

- Charlevoix Community Foundation
- The Women's Resource Center of Northern Michigan
- Charlevoix County Humane Society
- Boyne City Police & Fire Departments

We also believe in the values instilled by participating in athletic competition. It is our pleasure to be a sponsor in multiple Jr. Dragster competitions and to individually sponsor track champion Hunter "Ace" Acha. Additionally, we enjoy sponsoring a local Major League Softball team and supporting the annual Boyne City soap box derby. Our open house also raises money each year for a different local organization.

Within the industry we enjoy sponsoring the Goodguys Trophy Dash award and the NSRA Pro's Pick award each year. Since its inception in 1977, Classic Instruments has a history of involvement with the groups and associations that helped form the industry we are so proud to be a part of...

- '79 Inaugural NSRA Nationals attendee
- '83 Inaugural Goodguys Show attendee
- '85 SEMA membership
- '08 SEMA show attendance



Manufacturer of the year 2012



HRIA Business of the Year 2012



## Find Us

Visit us in your favorite circles for the latest news, shows, and cool stuff.



**Facebook**

[facebook.com/ClassicInstruments](https://facebook.com/ClassicInstruments)



**Instagram**

[classic\\_instruments](https://classic_instruments)



**Twitter**

[Classic Instruments @gaugeguru](https://ClassicInstruments@gaugeguru)



**Google+**

[plus.google.com/+ClassicInstrumentsBoyneCity](https://plus.google.com/+ClassicInstrumentsBoyneCity)

Classic Instruments attends over 20 shows and events throughout the year including Goodguys shows, NSRA shows, SEMA, and others.



**WARNING** This product can expose you to Lead which is known to the State of California to cause cancer or birth defects or other reproductive harm. For more information go to [www.P65Warnings.ca.gov](http://www.P65Warnings.ca.gov).



PURE MICHIGAN®

We proudly manufacture in the United States and support our troops, as well as local police, fire, and rescue service departments.



*The finishing touch*

CLASSIC INSTRUMENTS

800.575.0461 | 826 Moll Dr., Boyne City, MI 49712 | [classicinstruments.com](http://classicinstruments.com)

