

Classic Instruments

1963-1965

Nova

Installation Manual

Table of Contents

Welcome from the Team at Classic Instruments!	3
Removing the Original Instrument Cluster from the Dash	4
Disassembling the Original Instrument Cluster.....	5
Assembling the New Instrument Cluster	6
Wiring Diagram.....	7
Wiring Your New Instrument Cluster	8
Speedometer Wiring with SN16 Signal	8
SN16 Signal Calibration.....	8
16,000 PPM Speedometer Calibration Chart.....	9
Speedometer Wiring with SN74 Signal Interface.....	10
SN74Z Dip Switch Settings	11
Speedometer Dip Switch Settings.....	12
SN74Z Speedometer Calibration Modes	12
Instant Calibration Mode	12
Real-Time Calibration Mode	13
Marked Mile Calibration Mode.....	14
Tachometer / Quad Gauge Wiring	15
Tachometer Calibration.....	15
Oil Pressure Sender Installation	16
Temperature Sender Installation	17
Mount Your New Wired Instrument Cluster in Dash	18

Welcome from the Team at Classic Instruments!

Our congratulations and appreciation for your purchase of one of the finest quality sets of specialty instruments ever produced! Your instrument set has been conceived, designed, and manufactured by Classic Instruments, Inc. in the U.S.A. Each instrument has been tested and certified for accuracy and quality before packaging and shipping.

For trouble-free installation and operation follow the instructions exactly as outlined. Your instruments were assembled to precise specifications and although each has a seven (7) year warranty covering defective parts and workmanship – this warranty will not cover instruments or sender units which have been installed incorrectly.

Follow our recommended procedures for installation and proper hookup to maintain the value and appearance of your instrument set during many future years of accurate and dependable service!

LIMITED WARRANTY

Classic Instruments, Inc. (CI) warrants to the original purchaser that any CI product manufactured or supplied by CI will be free from defects in material and workmanship under normal use and service for a period of seven (7) years from date of purchase.

Improper installation, use of sending units other than CI's or attempted repair or adjustments by other than CI shall void this warranty. Disassembly of any instruments or senders for whatever reason shall specifically void this warranty.

It's always easy to look to a part for an issue with your set. Before you conclude that a part may be bad, thoroughly check your work. Today's semiconductors and passive components have reached incredibly high reliability levels, but there is still room for error in our human construction skills. However, on rare occasions a sour part can slip through. Please be aware that testing can usually determine if the part was truly defective or damaged by assembly or usage. Don't be afraid of telling us that you "blew it", we're all human and in most cases, replacement parts are very reasonably priced.

Purchaser requesting a product to be repaired or replaced under warranty must first call CI at 1-800-575-0461 before the return of defective part. Send defective part to 826 Moll Drive, Boyne City, MI 49712, USA. Include a written description of the failure with defective part.

Purchaser agrees and accepts that under no circumstances will a warranty replacement be furnished until CI has first received, inspected, and tested the returned part.

All other warranties expressed or implied are hereby excluded including any implied warranty of merchandise and implied warranty of fitness for a particular purpose. The sole and exclusive remedy for breach of this warranty is limited to the replacement set forth above.

It is expressly agreed that there shall be no further remedy for consequential or other type of damage, including any claim for loss of profit, engine damage or injury.

TECHNICAL ASSISTANCE

1-800-575-0461

OR

Visit our website for the latest in gauge design and updates to our installation manual

www.classicinstruments.com

Removing the Original Instrument Cluster from the Dash

Remove the four screws securing the original instrument cluster into the dash. Save these screws to use when mounting the new instrument cluster back into the dash.



Disconnect the speedometer cable and remove all bulbs and wires from the original instrument cluster.



Disassembling the Original Instrument Cluster

Remove the four screws securing the original instrument cluster to the bezel. Keep these screws to use when securing the new instrument cluster to the bezel. Set the original gauges aside.



Remove the original diffuser and lens from the bezel. Save the large diffuser, bezel and green turn signal indicator inserts for use with the new instrument cluster. Set aside the small diffuser and old lens.

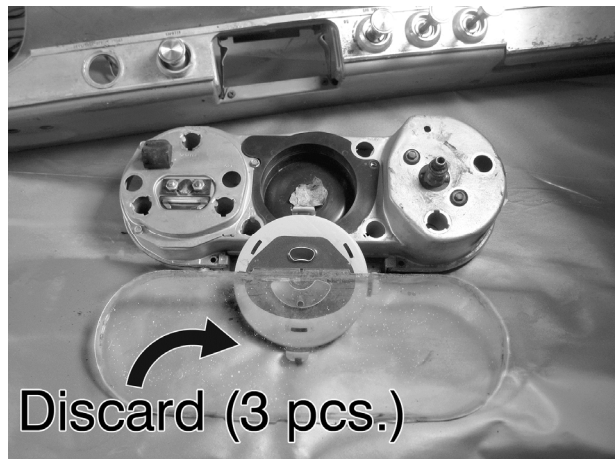

Assembling the New Instrument Cluster

If desired, paint the original diffuser to match your new instrument cluster before assembling.

Remove the protective covering from new lens and insert into the bezel. Replace diffuser over the new lens in the bezel. Place the original green turn signal inserts into the new turn signal tubes. Place the new turn signal tubes into the turn signal holes of the new instrument dial.

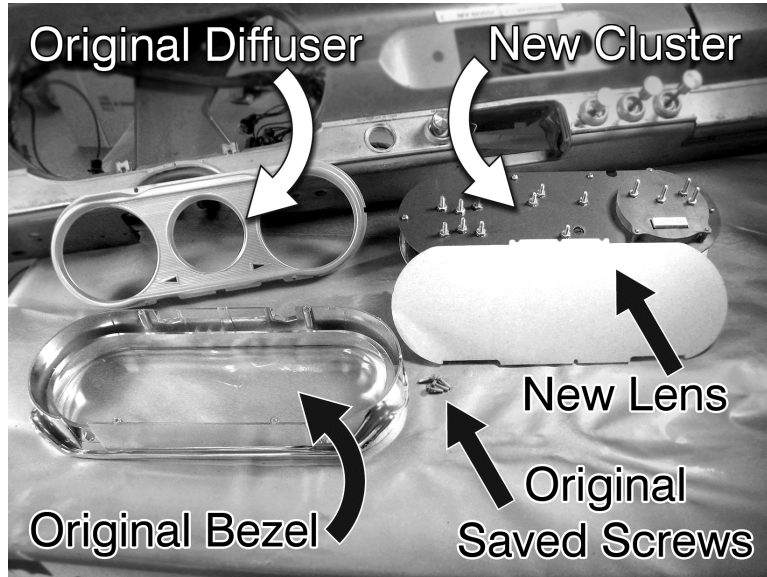

Secure the new instrument cluster to the bezel using the four screws saved from the original cluster.

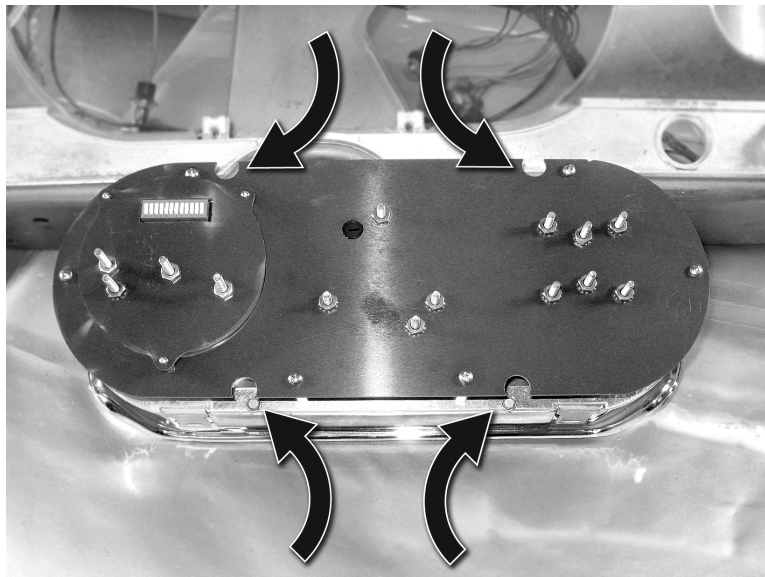

Wiring Diagram

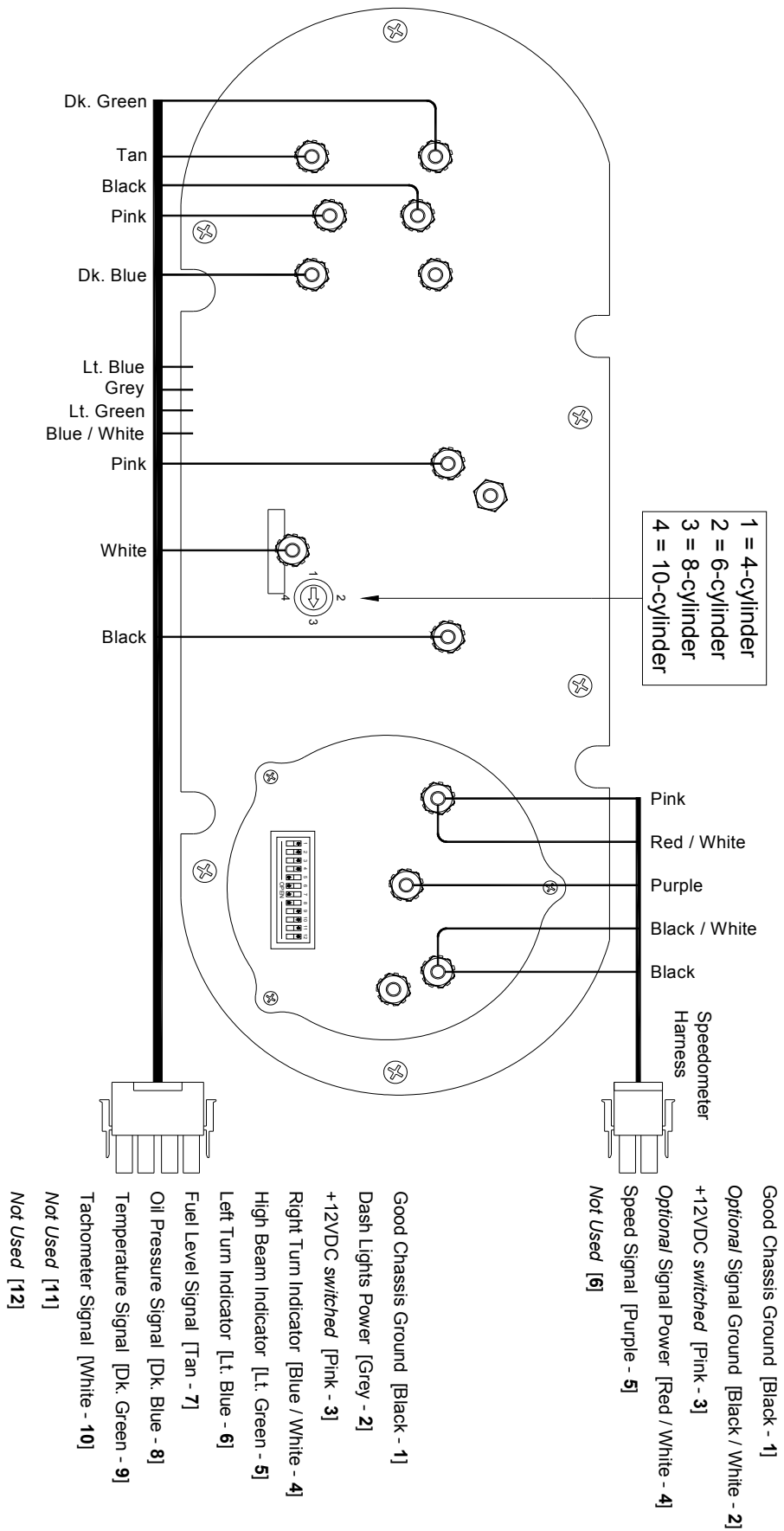

Wiring Your New Instrument Cluster

Speedometer Wiring with SN16 Signal

- 1) Always disconnect the positive lead from the vehicle battery before wiring any gauge.
- 2) Connect the **Black / White** wire of the speedometer wire harness to the black wire of the SN16 pulse signal generator.
- 3) Connect the **Purple** wire of the speedometer wire harness to the white wire of the SN16 pulse signal generator.
- 4) Connect the **Red / White** wire of the speedometer wire harness to the red wire of the SN16 pulse signal generator.
- 5) Connect the **Black** wire of the speedometer wire harness to a good chassis ground.
- 6) Connect the **Pink** wire of the speedometer wire harness to a switched +12VDC power source.

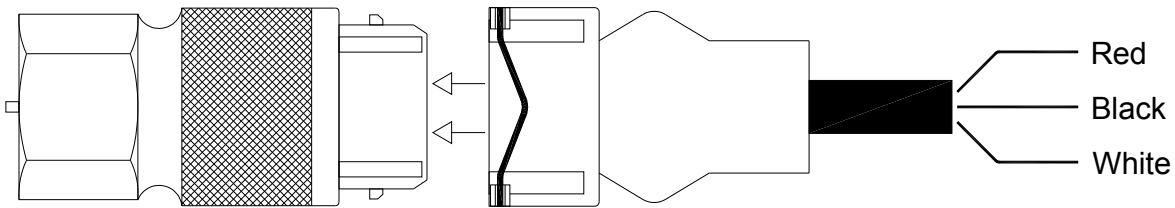

Red: +12VDC (to red / white wire of speedometer harness)
Black: Ground (to black / white wire of speedometer harness)
White: Signal (to purple wire of speedometer harness)

SN16 Signal Calibration

- 1) Turn off power to the speedometer.
- 2) Set the 12 dip switches on the back of the speedometer to their default position (5, 6, 7, 8 OPEN, all others CLOSED).
- 3) Check the current speedometer calibration at a known 60mph by pacing a vehicle with a calibrated speedometer or by using a GPS.
- 4) Note what the speedometer is indicating at a known 60mph.
- 5) Look up what the speedometer was indicating on the 16,000 PPM calibration chart and set the speedometer dip switches according to the chart. The dip switches shown on the chart should be the ONLY switches set to OPEN. All other dip switches should be set to CLOSED.
- 6) The speedometer should now be accurate. The dip switches must be set back to the default setting in order to use the calibration chart on future calibrations.

Default speedometer dip switch setting (5, 6, 7 and 8 OPEN):

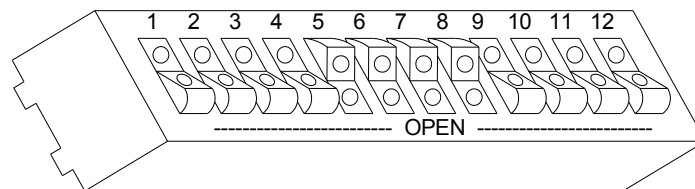

16,000 PPM Speedometer Calibration Chart

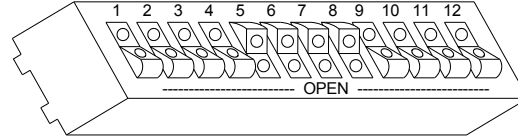

(Default Dip Switch Setting)

(Switch 5 6 7 8 OPEN)

Set speedometer switches **5 6 7 8 OPEN**, all others closed (*code for 16,000 PPM*). Drive vehicle at 60mph. If the speedometer reads other than 60, turn off power & set switches per chart below.

Speedometer Reading	OPEN SWITCH	Speedometer Reading	OPEN SWITCH
40 MPH	8 9 11 12	80 MPH	4 5 6 10 12
41 MPH	7 10 12	81 MPH	4 5 6 8
42 MPH	7 8	82 MPH	4 5 6 8 9 11 12
43 MPH	7 8 9 11 12	83 MPH	4 5 6 7 10
44 MPH	6 10	84 MPH	4 5 6 7 8
45 MPH	6 8	85 MPH	4 5 6 7 8 9 11 12
46 MPH	6 8 9 11 12	86 MPH	3 10 12
47 MPH	6 7 10 12	87 MPH	3 8
48 MPH	6 7 8	88 MPH	3 8 9 11 12
49 MPH	6 7 8 9 11 12	89 MPH	3 7 10 12
50 MPH	5 10	90 MPH	3 7 8
51 MPH	5 8	91 MPH	3 7 8 9 11 12
52 MPH	5 8 9 11 12	92 MPH	3 6 11 12
53 MPH	5 7 10 12	93 MPH	3 6 8
54 MPH	5 7 8	94 MPH	3 6 8 9 11 12
55 MPH	5 7 8 9 11 12	95 MPH	3 6 7 10 12
56 MPH	5 6 10 12	96 MPH	3 6 7 8
57 MPH	5 6 8	97 MPH	3 6 7 8 9 11 12
58 MPH	5 6 8 9 11 12	98 MPH	3 5 10 12
59 MPH	5 6 7 10 12	99 MPH	3 5 8
60 MPH	5 6 7 8	100 MPH	3 5 8 9 11 12
61 MPH	5 6 7 8 9 11 12	101 MPH	3 5 7 10 12
62 MPH	4 10 12	102 MPH	3 5 7 8
63 MPH	4 8	103 MPH	3 5 7 8 9 11 12
64 MPH	4 8 9 11 12	104 MPH	3 5 6 10 12
65 MPH	4 7 10	105 MPH	3 5 6 8
66 MPH	4 7 8	106 MPH	3 5 6 8 9 11 12
67 MPH	4 7 8 9 11 12	107 MPH	3 5 6 7 10 12
68 MPH	4 6 10 12	108 MPH	3 5 6 7 8
69 MPH	4 6 8	109 MPH	3 5 6 7 8 9 11 12
70 MPH	4 6 8 9 11 12	110 MPH	3 4 10 12
71 MPH	4 6 7 10 12	111 MPH	3 4 8
72 MPH	4 6 7 8	112 MPH	3 4 8 9 11 12
73 MPH	4 6 7 8 9 11 12	113 MPH	3 4 7 10 12
74 MPH	4 5 10 12	114 MPH	3 4 7 8
75 MPH	4 5 8	115 MPH	3 4 7 8 9 11 12
76 MPH	4 5 8 9 11 12	116 MPH	3 4 6 10 12
77 MPH	4 5 7 10 12	117 MPH	3 4 6 8
78 MPH	4 5 7 8	118 MPH	3 4 6 8 9 11 12
79 MPH	4 5 7 8 9 11 12	119 MPH	3 4 6 7 10 12

Speedometer Wiring with SN74 Signal Interface

- 1) Connect the red / white wire of the speedometer harness to the SN74Z terminal marked **+12 VOLTS**.
- 2) Connect the black / white wire of the speedometer harness to the SN74Z terminal marked **GROUND**.
- 3) Connect the red wire of a Classic Instruments SN16 pulse signal generator to the SN74Z terminal marked **SENDER +**. *If you are not using a pulse signal generator, this terminal is not used.*
- 4) Connect ¹⁾ one wire of an electronic transmission's vehicle speed sensor (VSS), ²⁾ one wire of a 2-wire pulse signal generator or ³⁾ the black wire of a Classic Instruments SN16 pulse signal generator to the SN74Z terminal marked **SENDER -**.
- 5) Connect ¹⁾ one wire of an electronic transmission's vehicle speed sensor (VSS), ²⁾ one wire of a 2-wire pulse signal generator, ³⁾ the white wire of a Classic Instruments SN16 pulse signal generator or ⁴⁾ a Computer (*ECM / PCM*) generated speed signal to the SN74Z terminal marked **SPEEDO IN**.
- 6) Connect the purple wire of the speedometer harness to the SN74Z terminal marked **OUTPUT**.
- 7) ^{Optional:} The SN74Z terminal marked **CRUISE** puts out an 8,000 pulse per mile 12-volt square wave signal that can be used as a signal source for a cruise control, lockup converter, etc...
- 8) Connect two wires from a momentary contact pushbutton to the two terminals on the SN74Z marked **BUTTON**. *A pushbutton is also mounted to the SN74Z that can be used in place of a remote button attached to the **BUTTON** terminals.*

Wiring Diagrams on Following Page

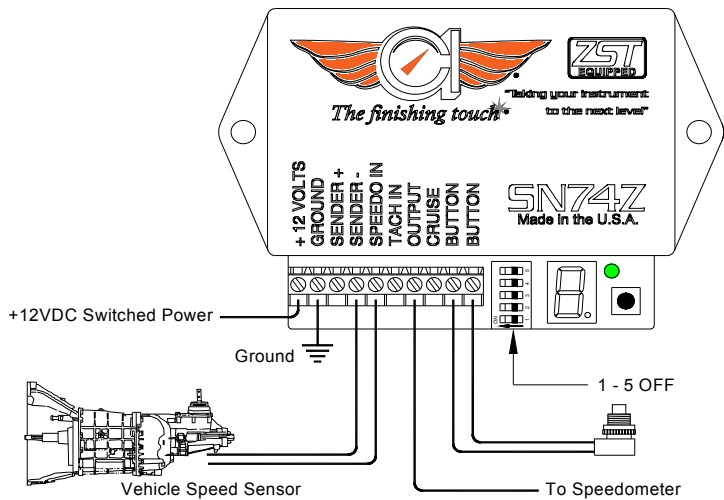

Figure 1: Vehicle Speed Sensor (VSS) Connection

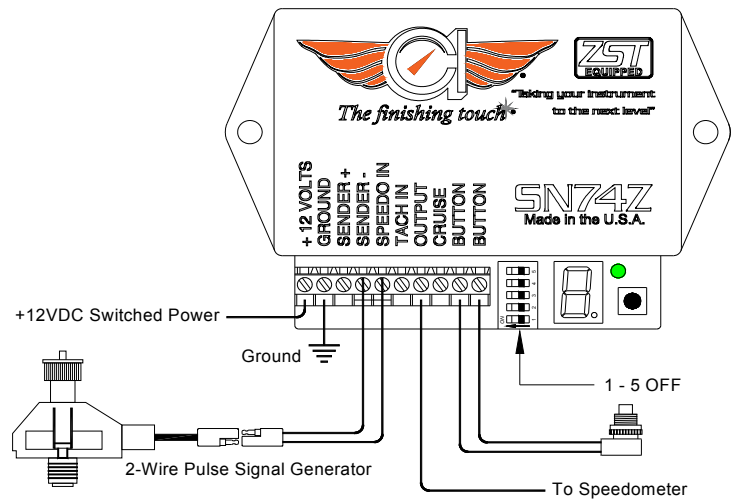

Figure 2: 2-wire Pulse Signal Generator Connection

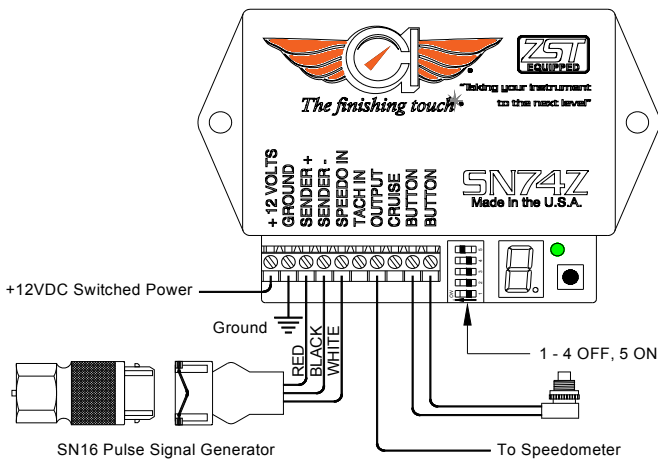

Figure 3: SN16 Pulse Signal Generator Connection

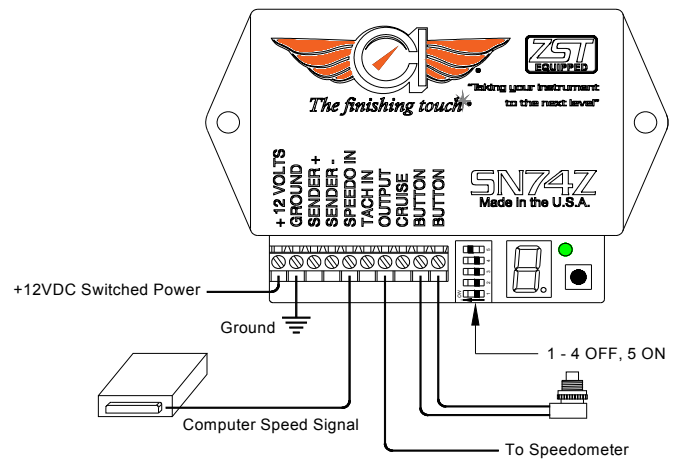

Figure 4: ECM/PCM Speed Signal Connection

SN74Z Dip Switch Settings

- Dip Switch #1:
 - Set switch #1 ON to set the output to 8,000 pulses per mile (ppm). (*Classic Instruments speedometers that have 8 dip switches on the back require 8,000 ppm*)
 - Set switch #1 OFF to set the output to 16,000 pulses per mile (ppm). (*Classic Instruments speedometers that have 12 dip switches on the back require 16,000ppm*)
- Dip Switch #5:
 - Set switch #5 ON for square wave speed signals such as ECM / PCM speed signals or SN16 / SN16F pulse signal generator signals.
 - Set switch #5 OFF for sine wave speed signals such as OEM vehicle speed sensor (VSS) signals or SN96 / SN95 pulse signal generator signals. (*sine wave signal sensors always have 2 wires*)
- Dip Switches #2 - #4 are NOT used

Speedometer Dip Switch Settings

Classic Instruments speedometers have a row of rocker switches on the back that are used to calibrate the speedometer in certain applications. However, if you are using a SN74Z, the speedometer rocker switches are not used to calibrate the speedometer.

- Switches **5, 6, 7, 8 OPEN** (*pushed in away from the number side of the switch*). All other switches (**1, 2, 3, 4 & 9, 10, 11, 12**) **CLOSED** (*pushed in toward the number side of the switch*).

SN74Z Speedometer Calibration Modes

There are three calibration modes you can use to calibrate the SN74Z. Use whichever mode seems easiest for your application. It is not necessary to perform all calibration modes.

Instant Calibration Mode

- Start with vehicle power off.
- Press and hold the calibration button and start the engine. *Once the engine is running, release the button.*
- The LED digit will display **C**, indicating entry into module select mode.
- After a few seconds, the LED digit will display **S**, **r** or **F**. Tap the button to cycle round robin through these setup options. Press and hold the button when the LED digit displays **S** (*indicating setup for speedometer applications*).
- Release the button when the LED digit displays **C**, indicating entry into calibration mode.
- Tap the button to change the LED digit to **1** indicating instant calibration mode. *Continuing to tap the button will cycle round robin through the calibration modes 1, 2, 3 and F.*
- Press and hold the button with the LED digit indicating **1** until the **1** starts blinking.
- Begin driving at 30 mph based on GPS or a pace car. (*The green LED on the SN74Z should blink indicating that it is getting a signal*).
- While driving steady at that speed, press and hold the button until the LED digit changes back to **C** (*to confirm that calibration is saved*).
- The speedometer should now begin reading 30 mph.
- Press and hold the button while the LED digit displays **C** to exit calibration mode. (*Tap the button to cycle round robin through the calibration modes again if you would like to perform another calibration*).

Real-Time Calibration Mode

- Start with vehicle power off.
- Press and hold the calibration button and start the engine. *Once the engine is running, release the button.*
- The LED digit will display **C**, indicating entry into module select mode.
- After a few seconds, the LED digit will display **S**, **r** or **F**. Tap the button to cycle round robin through these setup options. Press and hold the button when the LED digit displays **S** (*indicating setup for speedometer applications*).
- Release the button when the LED digit displays **C**, indicating entry into calibration mode.
- Tap the button to change the LED digit to **2** indicating real-time calibration mode. *Continuing to tap the button will cycle round robin through the calibration modes 1, 2, 3 and F.*
- Press and hold the button with the LED digit indicating **2** until the **2** starts blinking.
- Begin driving a known speed. *(The green LED on the SN74Z should blink, indicating that it is getting a signal).*
- Press and hold the button to change the speed shown on the speedometer. The first time the button is pressed and held, the speed shown on the speedometer will increase. The second time the button is pressed and held, the speed shown on the speedometer will decrease.
 - The SN74Z will alternate increasing or decreasing the speed shown on the speedometer each time the button is pressed. Press and hold the button to fine tune the speed shown on the speedometer.
- Once the speedometer is reading the correct speed, wait 8 seconds without pushing the button (*in order to save the calibration*). The LED digit will change back to **C** to confirm calibration is saved.
- Press and hold the button while the LED digit displays **C** to exit calibration mode. *(Tap the button to cycle round robin through the calibration modes again if you would like to perform another calibration).*

Marked Mile Calibration Mode

- Start with vehicle power off.
- Press and hold the calibration button and start the engine. *Once the engine is running, release the button.*
- The LED digit will display **C**, indicating entry into module select mode.
- After a few seconds, the LED digit will display **S**, **r** or **F**. Tap the button to cycle round robin through these setup options. Press and hold the button when the LED digit displays **S** (*indicating setup for speedometer applications*).
- Release the button when the LED digit displays **C**, indicating entry into calibration mode.
- Tap the button to change the LED digit to **3** indicating marked mile calibration mode. *Continuing to tap the button will cycle round robin through the calibration modes 1, 2, 3 and F.*
- Press and hold the button with the LED digit indicating **3** until the **3** starts blinking.
- Begin driving a known mile. (*The green LED on the SN74Z should blink, indicating that it is getting a signal*).
 - When driving the known mile, the speedometer will not indicate any speed. This is normal.
- At the end of the known mile, press and hold the button until the LED digit changes back to **C** to confirm calibration is saved.
- Press and hold the button while the LED digit displays **C** to exit calibration mode. (*Tap the button to cycle round robin through the calibration modes again if you would like to perform another calibration*).

Tachometer / Quad Gauge Wiring

- 1) Always disconnect the positive lead from the vehicle battery before wiring any gauge.
- 2) Connect the **Pink** wire of the wire harness to a +12VDC switched power source.
- 3) Connect the **Black** wire of the wire harness to a good chassis ground.
- 4) Connect the **Dark Green** wire of the wire harness to the supplied Classic Instruments temperature sender.
- 5) Connect the **White** wire of the wire harness to the tachometer signal.
 - a. **STANDARD POINTS & CONDENSER SYSTEM**
 - i. Connect to the negative side of the coil (usually marked as “-”).
 - b. **GMC – HEI (High Energy Ignition System)**
 - i. Connect to the “TACH” terminal on coil side of distributor cap.
 - c. **MSD (Multiple Spark Discharge System)**
 - i. Connect to the TACH signal from the MSD box.
 - d. **VERTEX MAGNETO SYSTEM**
 - i. Connect to the “KILL” terminal on the side of a Vertex magneto body. An external adapter such as an MSD “Pro Mag Tach Converter” #8132 may be required.
 - e. **ACCEL IGNITION COILS**
 - i. Connect to the negative side of the coil. CAUTION! Some Accel ignition coils require the tach signal wire to be connected to the “+” terminal on the coil! PLEASE carefully read Accel’s instructions before connecting ignition coil.
 - f. **MALLORY IGNITION**
 - i. Connect to the negative terminal side of coil (usually marked as “-”).
 - g. **ECM TACHOMETER SIGNAL**
 - i. Connect to the signal from the computer. The tachometer typically needs to be set on 4 cylinder setting.
 - h. **MULTIPLE COIL IGNITION SYSTEMS**
 - i. A tach adapter may be required for these ignition systems. A tach signal driver such as the MSD #8913, which produces a 12V square wave signal, is recommended. Please check with manufacturer for your specific application.
 - i. **NOTICE!** For all other ignition systems please look at the owner’s manual for that system.
- 6) Connect the **Tan** wire of the wire harness to the stock [0-90 ohm] fuel sender.
- 7) Connect the **Dark Blue** wire of the wire harness to the supplied Classic Instruments oil pressure sender.
- 8) Connect the **Blue / White** wire of the wire harness to the right turn indicator power wire of the vehicle’s turn signal switch.
- 9) Connect the **Light Blue** wire of the wire harness to the left turn indicator power wire of the vehicle’s turn signal switch.
- 10) Connect the **Light Green** wire of the wire harness to the high beam indicator power wire of the vehicle’s light switch.
- 11) Connect the **Grey** wire of the wire harness to the dash light power wire from the vehicle’s light switch.

Tachometer Calibration

Set the rotary switch on the back of the tachometer to the correct number of cylinder signal. Rotate the selector till it points to 1, 2, 3 or 4. **Note:** Most LS Engine tachometer signals are 4-cylinder (setting #1).

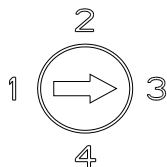

- 1 = 4-cylinder
- 2 = 6-cylinder
- 3 = 8-cylinder
- 4 = 10-cylinder

Oil Pressure Sender Installation

(Part No. SN52, SN53 & SN54)

- 1) Disconnect battery before installation.
- 2) Only install Classic Instruments sending units when the engine is COLD.
- 3) DO NOT use Teflon tape on the threads. These threads are slightly tapered and designed to be self-sealing. The sender uses the threads for its ground connection and sealant may cause a poor ground causing inaccurate readings

GM Installation: The correct location on most GM V8-engines to install the oil pressure sender is under the distributor housing at the rear of the block.

Use the 2 piece bushing kit provided to allow the sender to be mounted at a 45-degree angle pointing towards the driver's knees. This allows the sender to clear the back of the intake manifold, the underside of the distributor housing and also the firewall.

GM Installation – Big Block Engines: We do NOT recommend installing Classic Instrument's oil pressure sender in the opening located just above the oil filter on some big block GM engines. This location may not be a full-pressure passage but instead a "by-pass" oil passageway. Installing our pressure sender at this location may result in some strange low-pressure readings under certain driving conditions. This does not indicate a defective instrument or sender! It simply means you need to move the sender to the correct location.

GM Installation – LS Engines: Install the sender in the oil bypass housing located just above the oil filter. The housing will need to be drilled and tapped to 1/8"NPT.

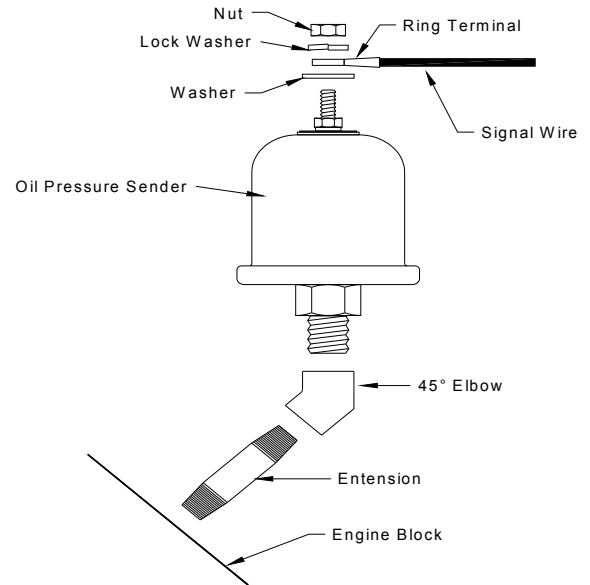

LS1 Oil Bypass Housing

Temperature Sender Installation

(Part No. SN12MM, SN22, SN23, SN24 & SN25)

- 1) Disconnect battery before making any connections.
- 2) Install the Classic Instrument's temperature sending unit only when the engine is COLD!
- 3) DO NOT use Teflon tape on the threads. These threads are slightly tapered and designed to be self-sealing. The sender uses the threads for its ground connection and sealant may cause a poor ground causing inaccurate readings
- 4) Install the temperature sender into the intake manifold of your engine as possible. Installing the sender in the engine cylinder head may cause inaccurate temperature readings.
 - a. On GM "LS" engines, the temperature sender mounts on the passenger side of the engine under the rear cylinder. A 12mm thread sender is available to fit this location.
- 5) Connect a wire from the top terminal of the temperature sender to the Dark Green wire of the gauge harness.
- 6) Tighten until snug. DO NOT OVER TIGHTEN!

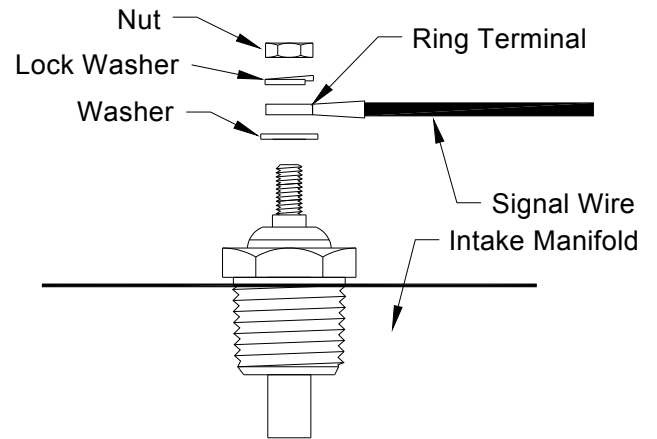

Notice: Avoid installing the temperature sender into the head of a late-model GMC engine. Even though the stock GMC sender may have been installed there, this opening is too close to the exhaust header and will most likely cause an improper reading.

Mount Your New Wired Instrument Cluster in Dash

Insert new instrument cluster into dash and secure using the four screws saved when removing the original instrument cluster.



Happy Hot Rodding!